

RoHS

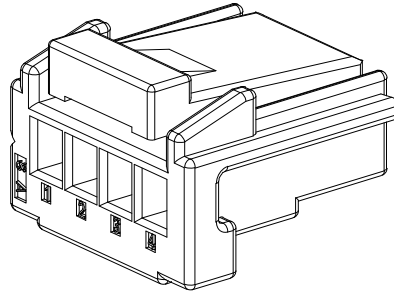

- Specifications(规格):
- Voltage rating(额定电压): 125V AC / DC
 - Current rating(额定电流): 2A AC / DC
 - Withstanding voltage(耐压值): 500V AC/minute
 - Temperature range(工作温度): -25°C~+85°C
 - Insulation resistance(绝缘电阻): $\geq 500M\Omega$
 - Contact resistance(接触电阻): $\leq 20m\Omega$
 - After environmental testing(环境测试后): $\leq 40m\Omega$

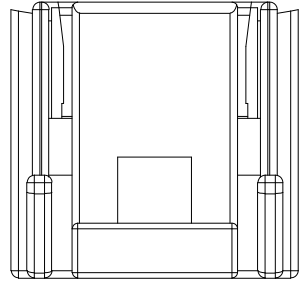
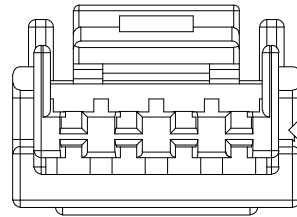
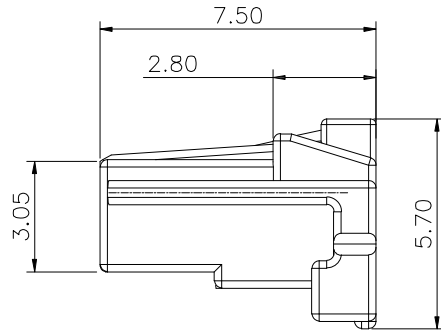

					GENERAL TOLERANCE .X ± 0.30 .XX ± 0.20 .XXX ± 0.10 X. $^{\circ}$ $\pm 2^{\circ}$				GYA 东莞市国亚电子有限公司 Connectors Dong Guan Guo Ya Connectors co., Ltd.				PART NO. A1510H-XXX							
					APPROVAL Yangzhengguo				CHECK Yangjinyi				DRAWN Lvtiansheng				DATE 2016/08/26			
PROJECT 													TITLE 1.5mm Crimp Style Connectors							
DATE	REV	ECN NO.	DESCRIPTION	MODIFY	APPROVAL							UNIT	SCALE	SHEET	REV	NUMBER				
1												mm	1:1	1/1	A0	A-007				

RoHS

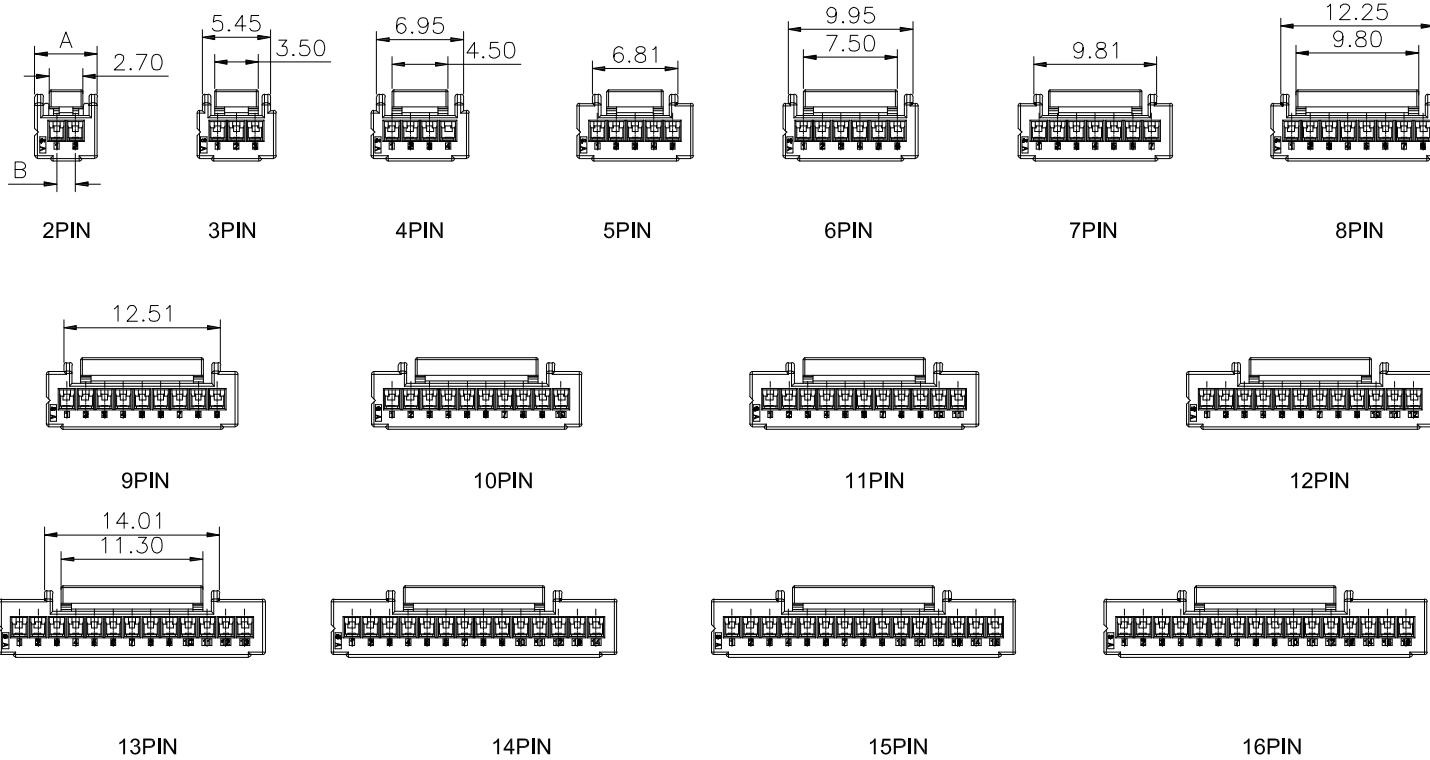

Poles	Dimensions(mm)		Poles	Dimensions(mm)		Poles	Dimensions(mm)	
	A	B		A	B		A	B
02	5.00	1.50	07	12.30	9.00	12	19.80	16.50
03	6.30	3.00	08	13.80	10.50	13	21.30	18.00
04	7.80	4.50	09	15.30	12.00	14	22.80	19.50
05	9.30	6.00	10	16.80	13.50	15	24.30	21.00
06	10.80	7.50	11	18.30	15.00	16	25.80	22.50



					GENERAL TOLERANCE .X ±0.30 .XX ±0.20 .XXX ±0.10 X.° ±2° PROJECT 				GYA 东莞市国亚电子有限公司 Connectors Dong Guan Guo Ya Connectors co., Ltd.				PART NO. A1510H-XXX																										
					APPROVAL Yangzhengguo				CHECK Yangjinyi				DRAWN Lviansheng				DATE 2016/08/26																						
DATE					REV					ECN NO.					DESCRIPTION					MODIFY					APPROVAL														
1					2					3					4					5					6					7					8				
UNIT		SCALE		SHEET		REV		NUMBER		mm		1:1		1/1		A0		A-007																					

RoHS

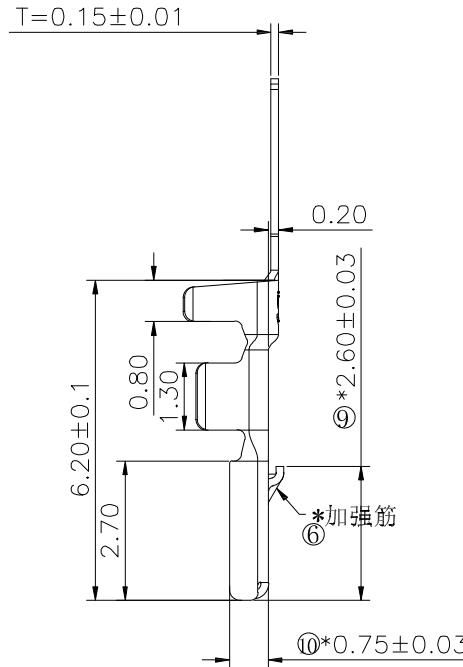
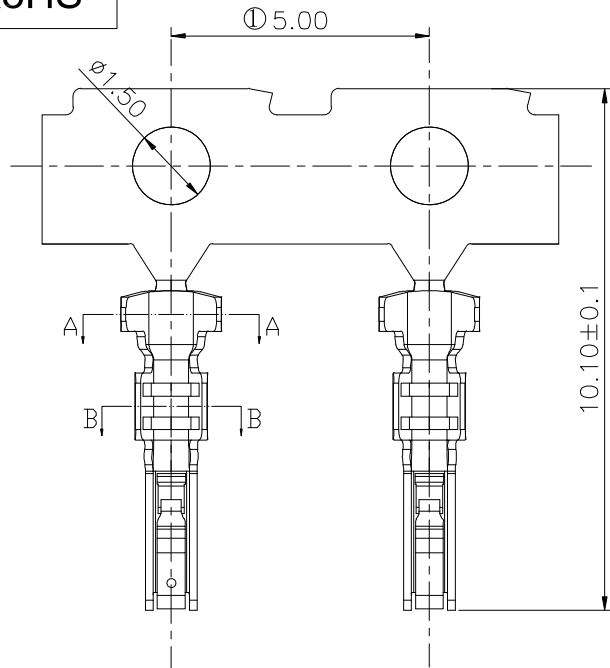

- Specifications :
- Voltage rating: 125V AC / DC
 - Current rating: 2A AC / DC
 - Withstanding voltage: 500V AC/minute
 - Temperature range: -25°C~+85°C
 - Insulation resistance: $\geq 500M\Omega$
 - Contact resistance: $\leq 20m\Omega$
 - After environmental testing: $\leq 40m\Omega$

- NOTES:
- Part No.: A1510T
 - Applicable Wire: AWG#24-28
 - Material: Phosphor Bronze THICKNESS: 0.15±0.01 MM
 - Q'ty: 10,000 Pcs/Reel

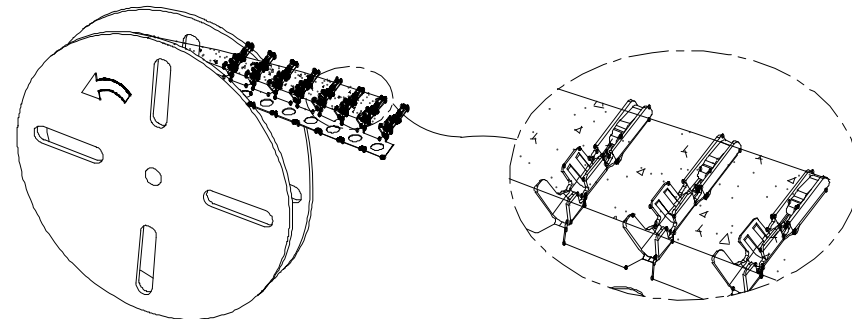
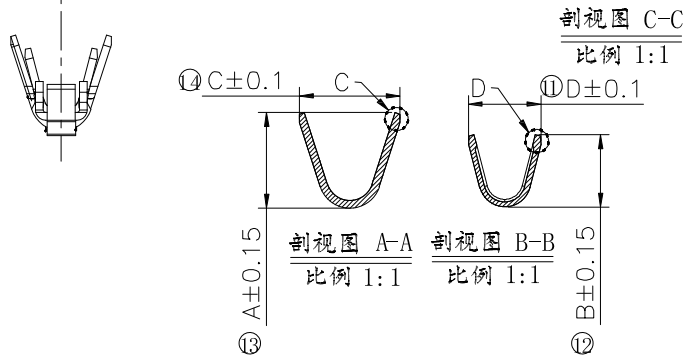

电镀后收料方向

比例 4:1

GENERAL TOLERANCE

- .X ±0.30
- .XX ±0.20
- .XXX ±0.10
- X.° ±2°

PROJECT



东莞市国亚电子有限公司
Dong Guan Guo Ya Connectors co., ltd.

APPROVAL CHECK DRAWN DATE

Yangzhengguo Yangjinyi Lvtiansheng 2016/08/26

PART NO.

A1510T-XXX

TITLE

1.50mm Crimp Style Connectors

UNIT	SCALE	SHEET	REV	NUMBER
mm	1:1	1/1	A0	A-007

DATE	REV	ECN NO.	DESCRIPTION	MODIFY	APPROVAL
1					

1 2 3 4 5 6 7 8

RoHS

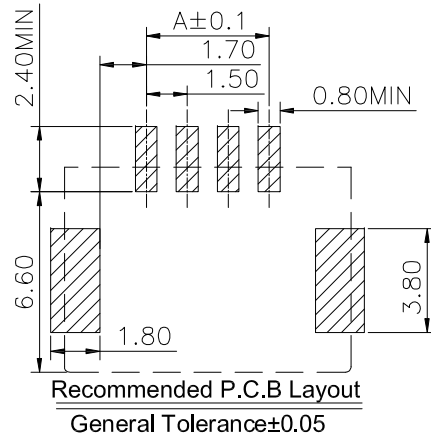
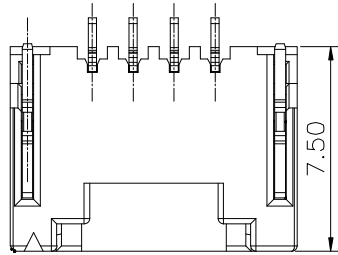

■ Specifications(规格) :

- Voltage rating(额定电压): 125V AC / DC
- Current rating(额定电流): 2A AC / DC
- Withstanding voltage(耐压值): 500V AC/minute
- Temperature range(工作温度): -25°C~+85°C
- Insulation resistance(绝缘电阻): $\geq 500M\Omega$
- Contact resistance(接触电阻): $\leq 20m\Omega$
- After environmental testing(环境测试后): $\leq 40m\Omega$

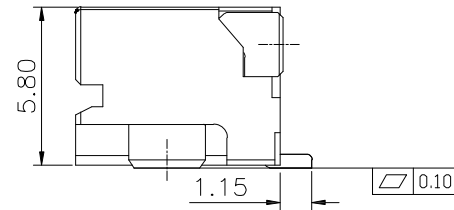
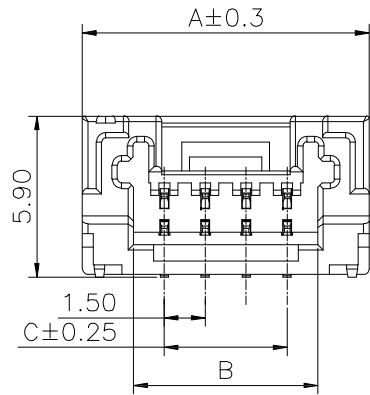

					GENERAL TOLERANCE .X ±0.30 .XX ±0.20 .XXX ±0.10 X.° ±2°				GYA 东莞市国亚电子有限公司 Connectors Dong Guan Guo Ya Connectors co., Ltd.				PART NO. A1510WRS-XXX							
					APPROVAL Yangzhengguo				CHECK Yangjinyi				DRAWN Lvtiansheng				DATE 2016/08/26			
					PROJECT 								TITLE 1.50mm Crimp Style Connectors							
DATE	REV	ECN NO.	DESCRIPTION	MODIFY	APPROVAL							UNIT	SCALE	SHEET	REV	NUMBER				
1		2										mm	1:1	1/1	A0	A-007				

RoHS

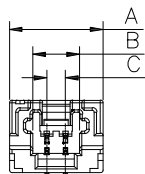

2PIN

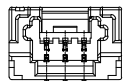

3PIN

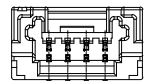

4PIN

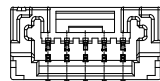

5PIN

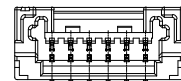

6PIN

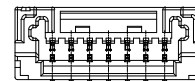

7PIN

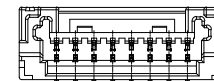

8PIN

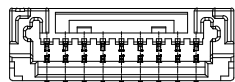

9PIN

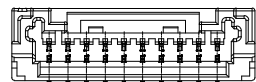

10PIN

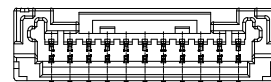

11PIN

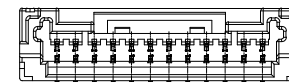

12PIN

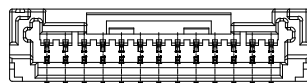

13PIN

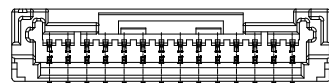

14PIN

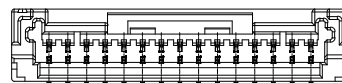

15PIN

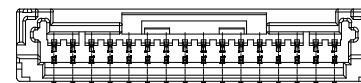

16PIN

Poles	Dimensions(mm)			Poles	Dimensions(mm)			Poles	Dimensions(mm)		
	A	B	C		A	B	C		A	B	C
02	7.50	3.75	1.50	07	15.00	11.25	9.00	12	22.50	18.75	16.50
03	9.00	5.25	3.00	08	16.50	12.75	10.50	13	24.00	20.25	18.00
04	10.50	6.75	4.50	09	18.00	14.25	12.00	14	25.50	21.75	19.50
05	12.00	8.25	6.00	10	19.50	15.75	13.50	15	27.00	23.25	21.00
06	13.50	9.75	7.50	11	21.00	17.25	15.00	16	28.50	24.75	22.50



GENERAL TOLERANCE

.X ±0.30

.XX ±0.20

.XXX ±0.10

X.° ±2°

PROJECT



东莞市国亚电子有限公司
Dong Guan Guo Ya Connectors co., ltd.

APPROVAL

CHECK

DRAWN

DATE

Yangzhengguo

Yangjinyi

Lvtiansheng

2016/08/26

PART NO.

A1510WRS-XXX

TITLE

1.50mm Crimp Style Connectors

UNIT

SCALE

SHEET

REV

NUMBER

mm

1:1

1/1

A0

A-007

DATE	REV	ECN NO.	DESCRIPTION	MODIFY	APPROVAL
1					
2					
3					
4					

RoHS

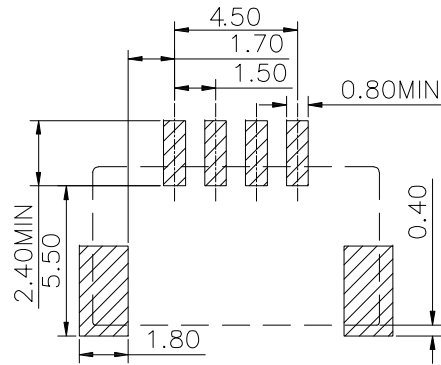
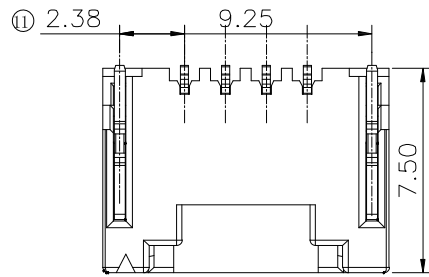

Recommended P.C.B Layout
General Tolerance±0.05

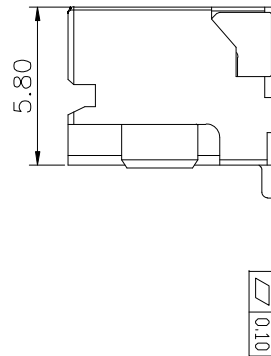
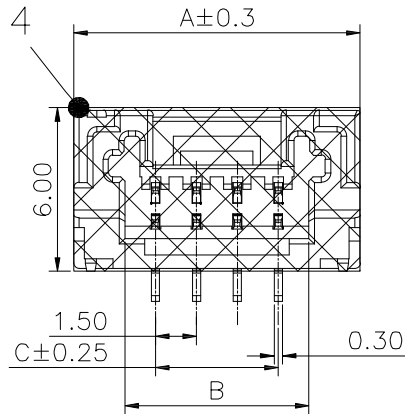

■ Specifications(规格) :

- Voltage rating(额定电压): 125V AC / DC
- Current rating(额定电流): 2A AC / DC
- Withstanding voltage(耐压值): 500V AC/minute
- Temperature range(工作温度): -25°C~+85°C
- Insulation resistance(绝缘电阻): ≥500MΩ
- Contact resistance(接触电阻): ≤20mΩ
- After environmental testing(环境测试后): ≤40mΩ



GENERAL TOLERANCE	
.X	±0.30
.XX	±0.20
.XXX	±0.10
X.°	±2°



东莞市国亚电子有限公司
Dong Guan Guo Ya Connectors co., Ltd.

PART NO.
A1510WVS-XXX

TITLE
1.50mm Crimp Style Connectors

APPROVAL	CHECK	DRAWN	DATE
Yangzhengguo	Yangjinyi	Lvtiansheng	2016/08/26

UNIT	SCALE	SHEET	REV	NUMBER
mm	1:1	1/1	A0	A-007

DATE	REV	ECN NO.	DESCRIPTION	MODIFY	APPROVAL
1					
2					

RoHS

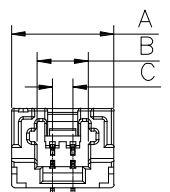

2PIN

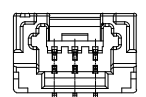

3PIN

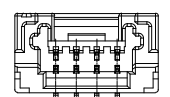

4PIN

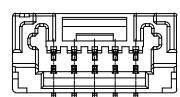

5PIN

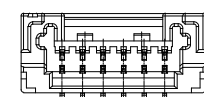

6PIN

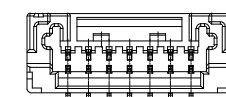

7PIN

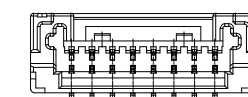

8PIN

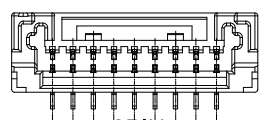

9PIN

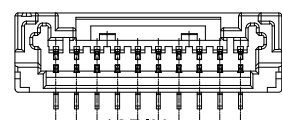

10PIN

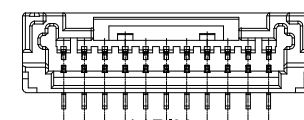

11PIN

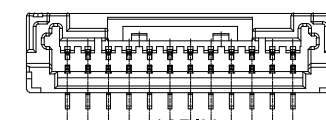

12PIN

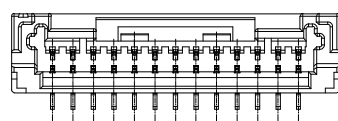

13PIN

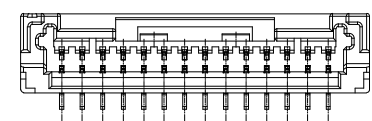

14PIN

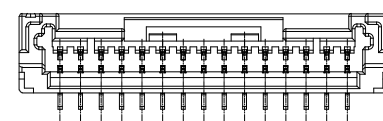

15PIN

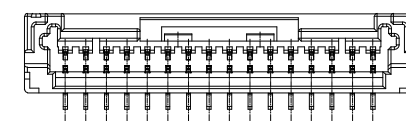

16PIN

Poles	Dimensions(mm)			Poles	Dimensions(mm)			Poles	Dimensions(mm)		
	A	B	C		A	B	C		A	B	C
02	7.50	3.75	1.50	07	15.00	11.25	9.00	12	22.50	18.75	16.50
03	9.00	5.25	3.00	08	16.50	12.75	10.50	13	24.00	20.25	18.00
04	10.50	6.75	4.50	09	18.00	14.25	12.00	14	25.50	21.75	19.50
05	12.00	8.25	6.00	10	19.50	15.75	13.50	15	27.00	23.25	21.00
06	13.50	9.75	7.50	11	21.00	17.25	15.00	16	28.50	24.75	22.50



GENERAL TOLERANCE	
.X	±0.30
.XX	±0.20
.XXX	±0.10
X.°	±2°



东莞市国亚电子有限公司
Dong Guan Guo Ya Connectors co., Ltd.

PART NO. A1510WVS-XXX

TITLE 1.50mm Crimp Style Connectors

PROJECT	Yangzhengguo
APPROVAL	Yangjinyi
CHECK	Lvtiansheng
DRAWN	2016/08/26
DATE	

APPROVAL	CHECK	DRAWN	DATE
Yangzhengguo	Yangjinyi	Lvtiansheng	2016/08/26

UNIT	SCALE	SHEET	REV	NUMBER
mm	1:1	1/1	A0	A-007

DATE	REV	ECN NO.	DESCRIPTION	MODIFY	APPROVAL
1		2	3	4	5