

RoHS

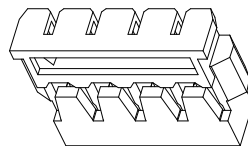

3D View

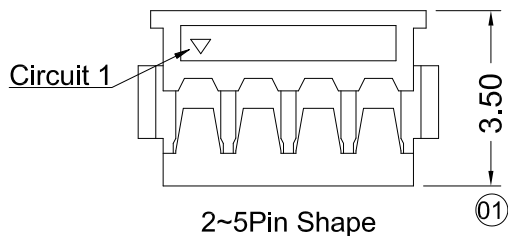

2~5Pin Shape

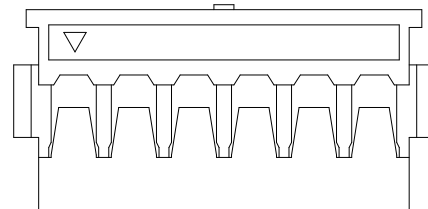

6Pin Shape

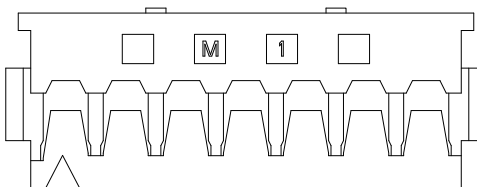
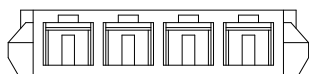

7Pin Shape

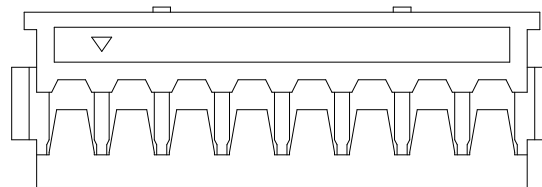
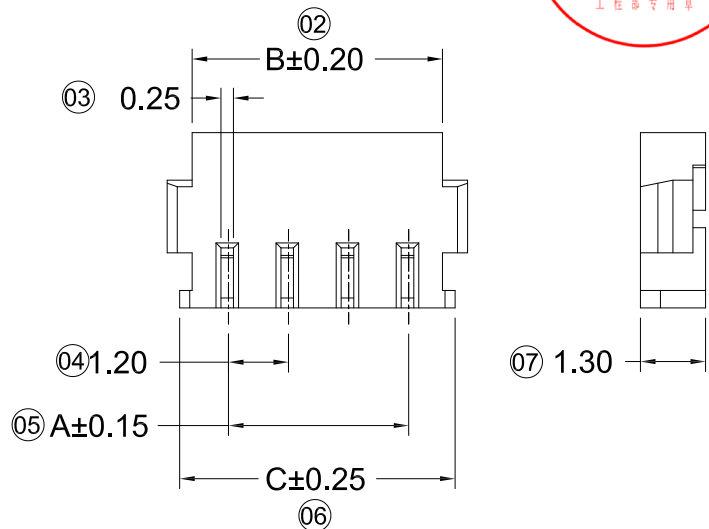

8~10Pin Shape

■ Specifications :

- Voltage rating: 50V AC / DC
- Current rating: 2A AC / DC
- Withstanding voltage: 500V AC/minute
- Temperature range: -40° ~+105°
- Insulation resistance: ≥100MΩ
- Contact resistance: ≤20mΩ
- After environmental testing: ≤40mΩ
- Mates With GYA Housing : A1202T / A1202W

A1202 H X- XX XX-LP XX

① ②③ ④ ⑤ ⑥ ⑦

- ① Series No.
- ② Category: H-HSG
- ③ Connector type: Blank-ordinary
- ④ Row No.-Pin No per row: XX-02~10P
- ⑤ Special No.
- ⑥ Material: LP-LCP 94V-0
- ⑦ Color: Blank-Natural Color Black

| Poles | Dimensions(mm) | | |
|-------|----------------|-------|-------|
| | A | B | C |
| 2 | 1.20 | 2.60 | 3.10 |
| 3 | 2.40 | 3.80 | 4.30 |
| 4 | 3.60 | 5.00 | 5.50 |
| 5 | 4.80 | 6.20 | 6.70 |
| 6 | 6.00 | 7.40 | 7.90 |
| 7 | 7.20 | 8.60 | 9.10 |
| 8 | 8.40 | 9.80 | 10.30 |
| 9 | 9.60 | 11.00 | 11.50 |
| 10 | 10.80 | 12.20 | 12.70 |

GENERAL TOLERANCE

- .X ±0.35
- .XX ±0.25
- .XXX ±0.15
- X.° ±2°

PROJECT

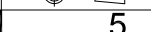

东莞市国亚电子有限公司
Dong Guan Guo Ya Connectors co., Ltd.

PART NO.

A1202H-XX-LP

TITLE 1.20 mm Crimp Style Connectors

APPROVAL CHECK DRAWN DATE

Yangzhengguo Yangzhengyi LvTiansheng 2016/08/26

| UNIT | SCALE | SHEET | REV | NUMBER |
|------|-------|-------|-----|--------|
| mm | 1:1 | 1/1 | A0 | A-022 |

| DATE | REV | ECN NO. | DESCRIPTION | MODIFY | APPROVAL |
|------|-----|---------|-------------|--------|----------|
| 1 | | | | | |
| 2 | | | | | |
| 3 | | | | | |
| 4 | | | | | |

RoHS



■ Specifications :

- Voltage rating: 50V AC / DC
- Current rating: 2A AC / DC
- Withstanding voltage: 500V AC/minute
- Temperature range: -40° ~+105°
- Insulation resistance: ≥100MΩ
- Contact resistance: ≤20mΩ
- After environmental testing: ≤40mΩ
- Material(Pin): Phosphor bronze
- Mates With GYA Housing : A1202H
- Wire Range: AWG#28-30
- Insulation O.D. : 0.70mm (Max.)

A1202 T X - P V01 X

- ① ② ③ ④ ⑤ ⑥

- ① Series Number
- ② Category: T-terminal
- ③ Shape: Blank-ordinary
- ④ Material: P-Phosphor bronze
- ⑤ Plating style: V01- All Gold Flash
- ⑥ Plating code:
Blank-Stamping before plating

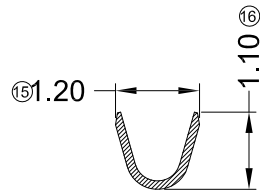
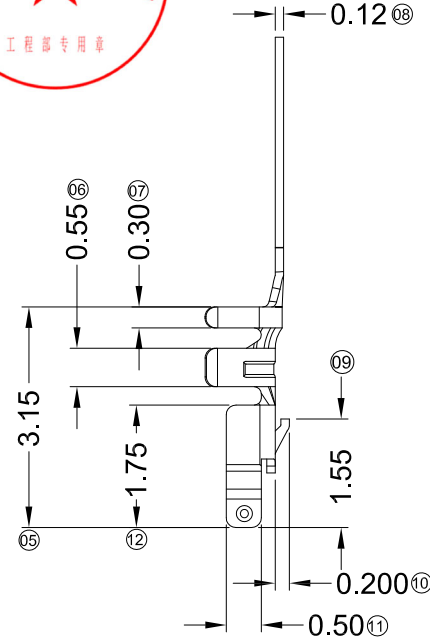
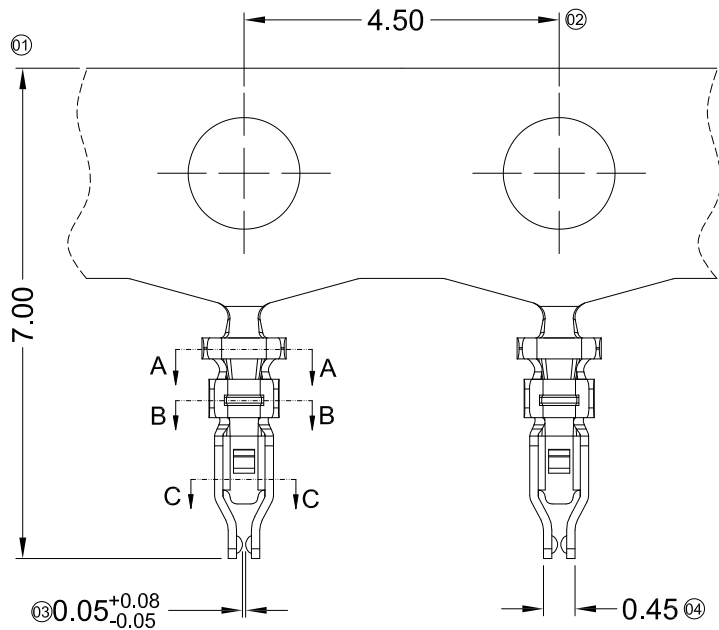

SECTION A-A
SCALE 1:1

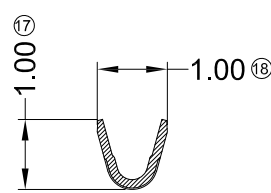

SECTION B-B
SCALE 1:1

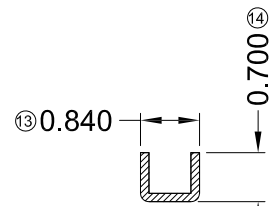

SECTION C-C
SCALE 1:1

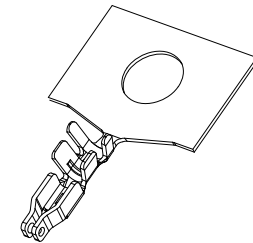

| GENERAL TOLERANCE | |
|-------------------|-------|
| .X | ±0.30 |
| .XX | ±0.20 |
| .XXX | ±0.10 |
| X.° | ±2° |



东莞市国亚电子有限公司
Dong Guan Guo Ya Connectors co., Ltd.

APPROVAL: Yangzhengguo, CHECK: Yangzhengyi, DRAWN: Lvtiansheng, DATE: 2016/08/26

PROJECT: Yangzhengguo

PART NO. A1202T-PV01

TITLE 1.20mm Crimp Style Connectors

| UNIT | SCALE | SHEET | REV | NUMBER |
|------|-------|-------|-----|--------|
| mm | 1:1 | 1/1 | A0 | A-014 |

| DATE | REV | ECN NO. | DESCRIPTION | MODIFY | APPROVAL |
|------|-----|---------|-------------|--------|----------|
| 1 | | | | | |

RoHS

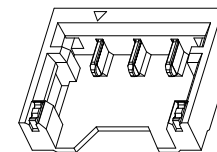

3D View

Specifications :

- Voltage rating: 50V AC / DC
- Current rating: 2A AC / DC
- Withstanding voltage: 500V AC/minute
- Temperature range: -40° ~+105°
- Insulation resistance: ≥100MΩ
- Contact resistance: ≤20mΩ
- After environmental testing: ≤40mΩ
- Material(Solder Tabs):Phosphor Bronze
- Finish(Solder Tabs):Matte Tin Plating
- Mates With GYA Housing : A1202H

A1202 W R S-XX X- XX V01 XX -X
 ① ② ③ ④ ⑤ ⑥ ⑦ ⑧ ⑨ ⑩

- ① Series No.
- ② Category: W-wafer
- ③ Connector type: R-Right Angle 90°
- ④ Mounting type: S-SMT
- ⑤ Row No.-Pin No per row: XX-02P~03P
- ⑥ Special No:
- ⑦ Material: LP-LCP 94V-0 ; 4T-PA4T
- ⑧ Planting Code: V01: All Gold Flash
V03: All Gold 3μ"
- ⑨ Color: Blank- Black Color
- ⑩ Pin Material: Blank-Phosphor Bronze
H-High conductivity copper

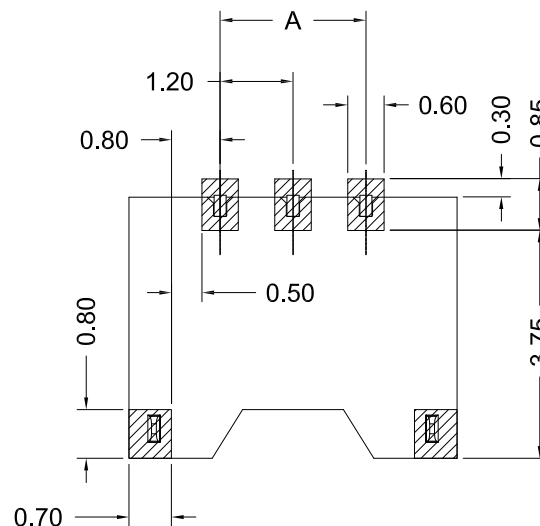

RECOMMENDED PCB LAYOUT
 GENERAL TOLERANCE ±0.05

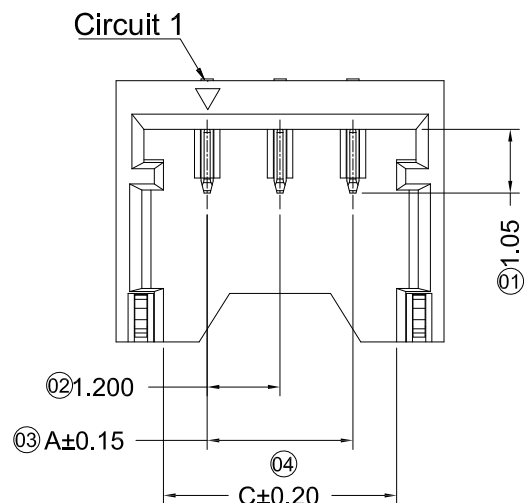
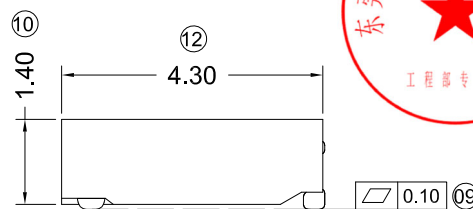

2-3 Pin
 Without Sticking Point

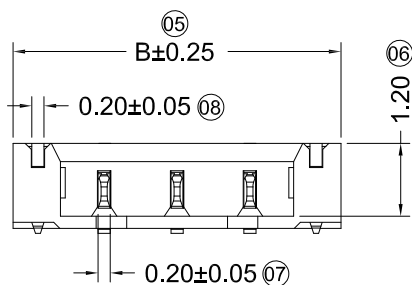

| Poles | Dimensions(mm) | | | Poles | Dimensions(mm) | | |
|-------|----------------|------|------|-------|----------------|------|------|
| | A | B | C | | A | B | C |
| 02 | 1.20 | 4.20 | 2.64 | 03 | 2.40 | 5.40 | 3.84 |

| GENERAL TOLERANCE | |
|-------------------|-------|
| .X | ±0.30 |
| .XX | ±0.20 |
| .XXX | ±0.10 |
| X.° | ±2° |



东莞市国亚电子有限公司
 Dong Guan Guo Ya Connectors co.,ltd.

PART NO.
 A1202WRS-XX-XXVXXX-X

TITLE 1.20mm CrImp Style Connectors

APPROVAL CHECK DRAWN DATE

PROJECT Yangzhengguo Yangzhengyi Lvtiansheng 2016/08/26

| UNIT | SCALE | SHEET | REV | NUMBER |
|------|-------|-------|-----|--------|
| mm | 1:1 | 1/1 | A0 | A-000 |

| DATE | REV | ECN NO. | DESCRIPTION | MODIFY | APPROVAL |
|------|-----|---------|-------------|--------|----------|
| 1 | | | | | |
| 2 | | | | | |
| 3 | | | | | |
| 4 | | | | | |

RoHS

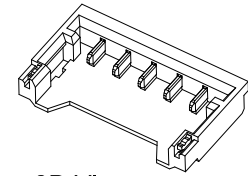

3D View

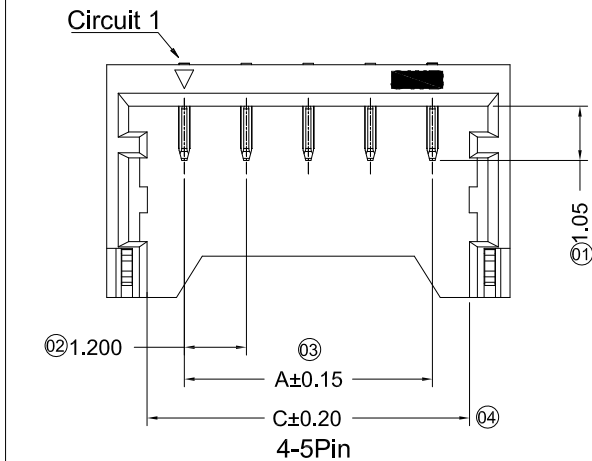

Without Sticking Point

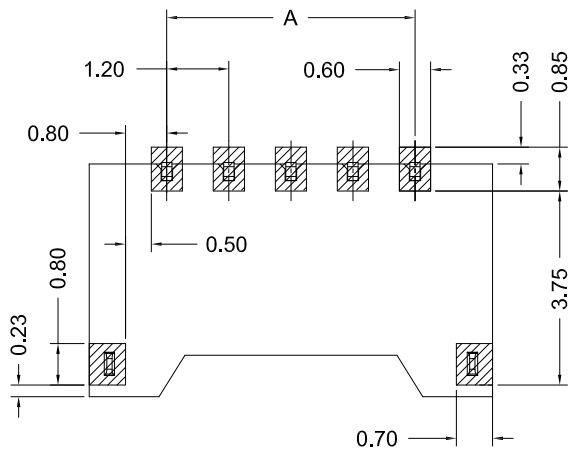

RECOMMENDED PCB LAYOUT
GENERAL TOLERANCE ±0.05

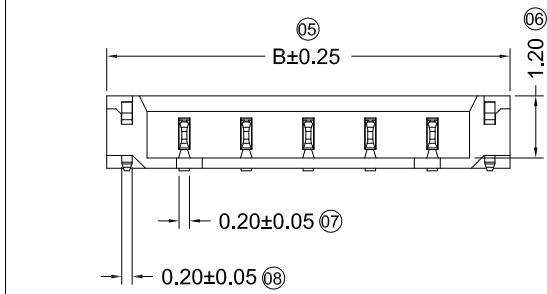

6P With Sticking Point
Scale 1:1

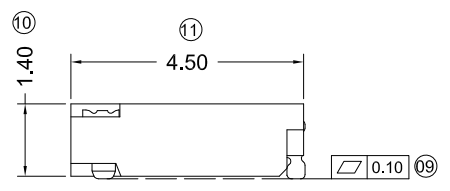

7~10P With Sticking Point
Scale 1:1

- Specifications :
- Voltage rating: 50V AC / DC
 - Current rating: 2A AC / DC
 - Withstanding voltage: 500V AC/minute
 - Temperature range: 40° ~+105°
 - Insulation resistance: ≥100MΩ
 - Contact resistance: ≤20mΩ
 - After environmental testing: ≤40mΩ
 - Material(Solder Tabs):Phosphor Bronze
 - Finish(Solder Tabs):Matte Tin Plating
 - Mates With GYA Housing : A1202H

A1202 W R S - XX L - XX V01 XX - X
① ② ③ ④ ⑤ ⑥ ⑦ ⑧ ⑨ ⑩

- ① Series No.
- ② Category: W-wafer
- ③ Connector type: R-Right Angle 90°
- ④ Mounting type: S-SMT
- ⑤ Row No.-Pin No per row: XX-04P~10P
- ⑥ Special No.: L-36 Edition
- ⑦ Material: 4T-PA4T 94V-0; LP-LCP 94V-0
- ⑧ Planting Code: V01: All Gold Flash
V03: All Gold 3μ"
- ⑨ Color: Blank-Black Color
- ⑩ Pin Material :Blank-Phosphor Bronze
H-High conductivity copper

| Poles | Dimensions(mm) | | | Poles | Dimensions(mm) | | |
|-------|----------------|-------|------|-------|----------------|-------|-------|
| | A | B | C | | A | B | C |
| 04 | 3.60 | 6.60 | 5.04 | 08 | 8.40 | 11.40 | 9.84 |
| 05 | 4.80 | 7.80 | 6.24 | 09 | 9.60 | 12.60 | 11.04 |
| 06 | 6.00 | 9.00 | 7.44 | 10 | 10.80 | 13.80 | 12.24 |
| 07 | 7.20 | 10.20 | 8.64 | | | | |

| | | | | | | | | | | | | | | |
|------|-----|---------|-------------|--------|-------------------|--|--|--|--|-------------------------------------|-------------|-------------|------------|-----------------------------|
| | | | | | GENERAL TOLERANCE | 东莞市国亚电子有限公司 Dong Guan Guo Ya Connectors co., Ltd. | | | | PART NO. A1202WRS-XXL-XXV01XX-X | | | | |
| | | | | | .X ±0.30 | | | | | TITLE 1.20mm Crimp Style Connectors | | | | |
| | | | | | .XX ±0.20 | | | | | APPROVAL | | | | |
| | | | | | .XXX ±0.10 | | | | | Yangzhengguo | Yangzhengyi | Lvitansheng | 2016/08/26 | UNIT SCALE SHEET REV NUMBER |
| DATE | REV | ECN NO. | DESCRIPTION | MODIFY | APPROVAL | | | | | mm | 1:1 | 1/1 | A0 | A-000 |