

RoHS

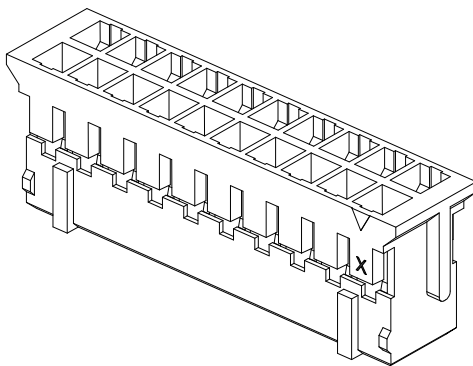

- Specifications :**
- Voltage rating: 250V AC / DC
 - Current rating: 3A AC / DC
 - Withstanding voltage: 800V AC/minute
 - Temperature range: -25° ~+85°
 - Insulation resistance: ≥1000MΩ
 - Contact resistance: ≤10mΩ
 - After environmental testing: ≤20mΩ
 - Suitable GYA Terminal: A2006T
 - Mates With GYA Wafer: A2006W

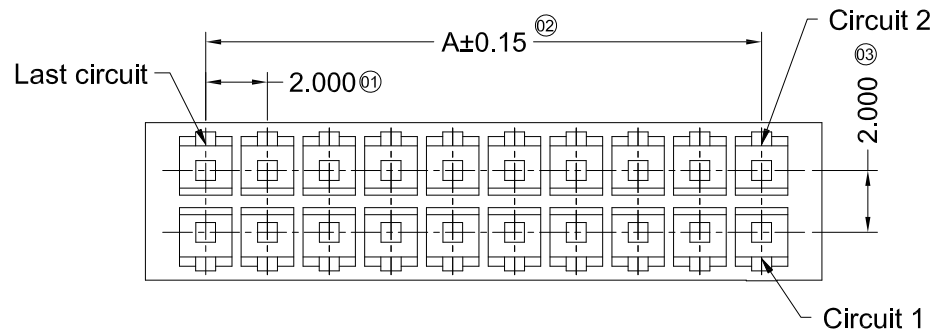
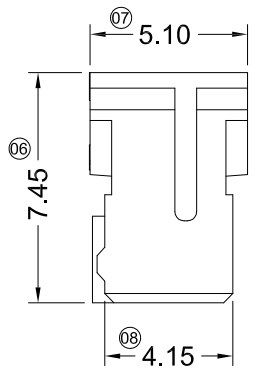
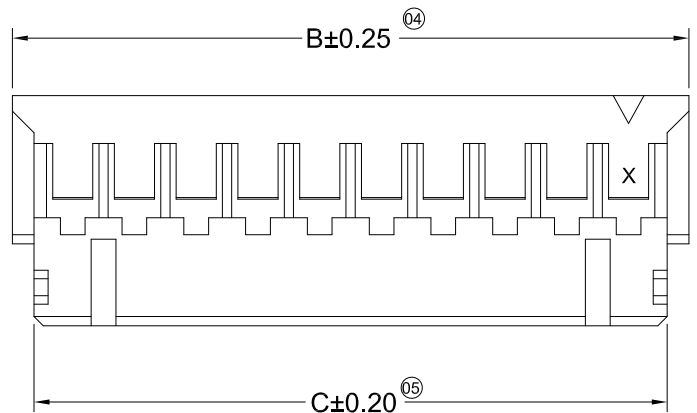

A2006 H X-2*XX HF-N0 XX

① ② ③ ④ ⑤ ⑥ ⑦

- ① Series No.
- ② Category: H-HSG
- ③ Appearance type: Blank-Ordinary
- ④ Row No.-Pin No.: 2*XX-2*02P~2*22P
- ⑤ Special No.: HF-Halogen Free
- ⑥ Material: N0-PA66 94V-0
- ⑦ Color: Blank-Natural Color 、BK-Black

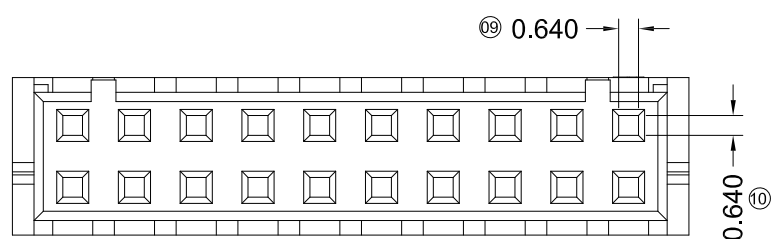

Poles	Dimensions (mm)			Poles	Dimensions (mm)		
	A	B	C		A	B	C
2*02	2.00	5.90	4.50	2*13	24.00	27.90	26.50
2*03	4.00	7.90	6.50	2*14	26.00	29.90	28.50
2*04	6.00	9.90	8.50	2*15	28.00	31.90	30.50
2*05	8.00	11.90	10.50	2*16	30.00	33.90	32.50
2*06	10.00	13.90	12.50	2*17	32.00	35.90	34.50
2*07	12.00	15.90	14.50	2*18	34.00	37.90	36.50
2*08	14.00	17.90	16.50	2*19	36.00	39.90	38.50
2*09	16.00	19.90	18.50	2*20	38.00	41.90	40.50
2*10	18.00	21.90	20.50	2*21	40.00	43.90	42.50
2*11	20.00	23.90	22.50	2*22	42.00	45.90	44.50
2*12	22.00	25.90	24.50				

DATE	REV	ECN NO.	DESCRIPTION	MODIFY	APPROVAL
1					
2					
3					
4					

GENERAL TOLERANCE .X ±0.30 .XX ±0.20 .XXX ±0.10 X.° ±2° PROJECT				GYA 东莞市国亚电子有限公司 Connectors Dong Guan Guo Ya Connectors co., Ltd.				PART NO. A2006H-2*XXXX-N0			
APPROVAL Yangzhengguo CHECK Yangjingyi DRAWN Lvtiansheng DATE 2016/08/26				TITLE 2.00mm Crimp Style Connectors				UNIT SCALE SHEET REV NUMBER mm 1 : 1 1/1 A0 A-022			

RoHS

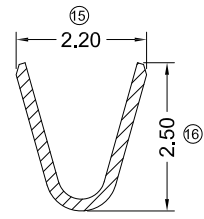
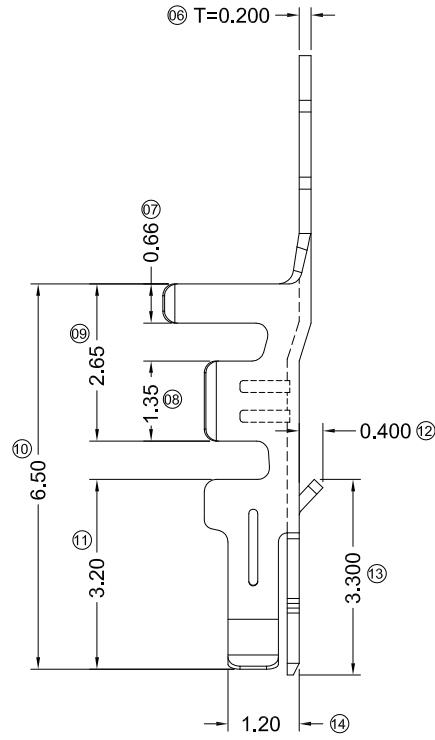
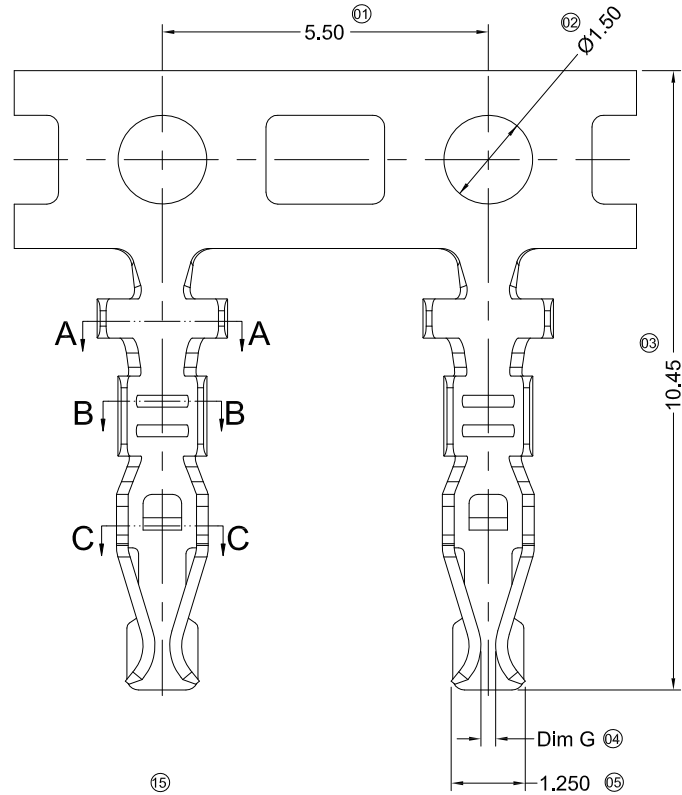

SECTION: A-A
SCALE: 1:1

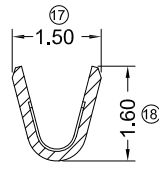

SECTION: B-B
SCALE: 1:1

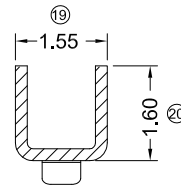

SECTION: C-C
SCALE: 1:1



■ Specifications :

- Voltage rating: 250V AC / DC
- Current rating: 3A AC / DC
- Withstanding voltage: 800V AC/minute
- Temperature range: -25° ~+85°
- Insulation resistance: ≥1000MΩ
- Contact resistance: ≤10mΩ
- After environmental testing: ≤20mΩ
- Wire Size:AWG#22~28
- Insulation O.D.: 1.50mm (Max)
- Used In GYA Housing : A2006H 、 A2006H-A

A2006 T X-P XXX X - X
① ② ③ ④ ⑤ ⑥ ⑦

- ① Series Number
- ② Category: T-terminal
- ③ Shape: Blank-ordinary
- ④ Material : P-Phosphor bronze
- ⑤ Plating Code : SN-Bright tin ; V01-Gold Flash
G03-Gold 3u" Plated Contact
- ⑥ Plating method : Blank-Stamping before plating
B-Plating before stamping
- ⑦ Mold No./Mark/Special No.: T- Tight L- Loose

Dimensions "G"(mm)	
A2006T-PXXX-T	0.25mm
A2006T-PXXX-L	0.33mm

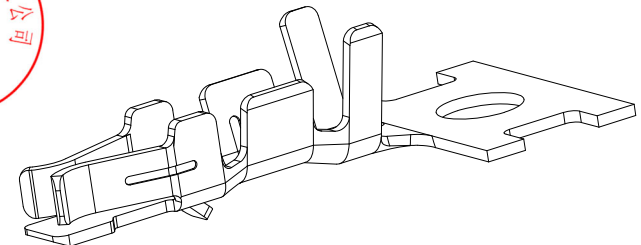

DATE	REV	ECN NO.	DESCRIPTION	MODIFY	APPROVAL
1					
2					
3					
4					
5					

GENERAL TOLERANCE
.X ±0.30
.XX ±0.20
.XXX ±0.10
X.° ±2°
PROJECT

	东莞市国亚电子有限公司 Dong Guan Guo Ya Connectors co., Ltd.			
	APPROVAL	CHECK	DRAWN	DATE
	Yangzhengguo	Yangjingyi	Lvtiansheng	2016/08/26

PART NO.				
A2006T-PXXX-X				
TITLE				
2.00mm Crimp Style Connectors				
UNIT	SCALE	SHEET	REV	NUMBER
mm	1:1	1/1	A0	A-000

RoHS

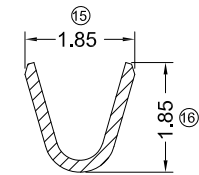
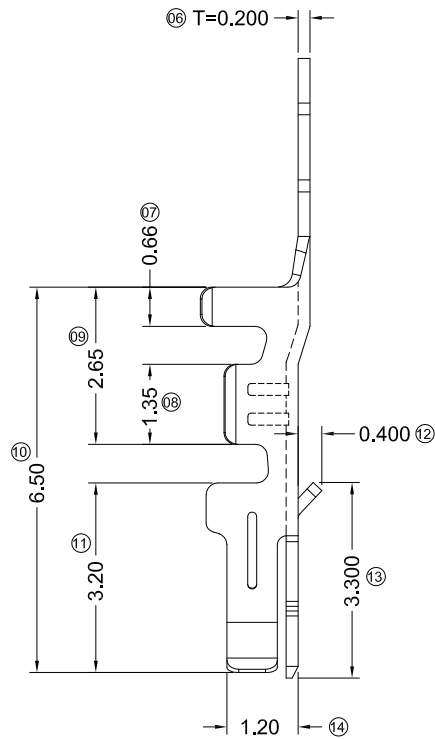
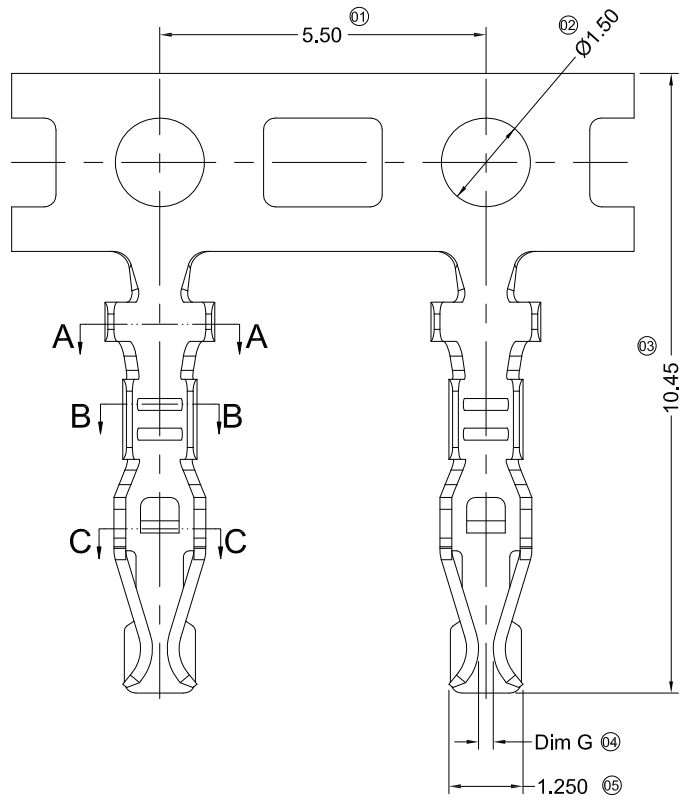

SECTION: A-A
SCALE: 1:1

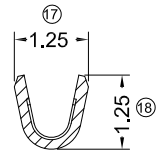

SECTION: B-B
SCALE: 1:1

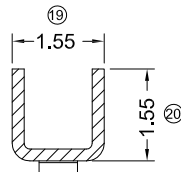

SECTION: C-C
SCALE: 1:1

■ Specifications :

- Voltage rating: 250V AC / DC
- Current rating: 3A AC / DC
- Withstanding voltage: 800V AC/minute
- Temperature range: -25° ~+85°
- Insulation resistance: ≥1000MΩ
- Contact resistance: ≤10mΩ
- After environmental testing: ≤20mΩ

- Wire Size:AWG#28~32
- Insulation O.D.: 1.00mm (Max)
- Used In GYA Housing : A2006H 、 A2006H-A

A2006 T L-P XXX X - X
① ② ③ ④ ⑤ ⑥ ⑦

- ① Series Number
- ② Category : T-terminal
- ③ Shape: L-Lower Crimp
- ④ Material : P-Phosphor bronze
- ⑤ Plating Code : SN-Bright tin ; V01-Gold Flash
G03-Gold 3u" Plated Contact
- ⑥ Plating method: Blank-Stamping before plating
B-Plating before stamping
- ⑦ Mold No./Mark/Special No.: T- Tight L- Loose

Dimensions "G"(mm)	
A2006TL-PXXX-T	0.25mm
A2006TL-PXXX-L	0.33mm

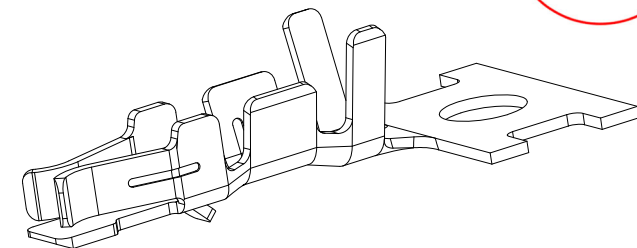

GENERAL TOLERANCE

.X	±0.30
.XX	±0.20
.XXX	±0.10
X.°	±2°

PROJECT



东莞市国亚电子有限公司
Dong Guan Guo Ya Connectors co., Ltd.

APPROVAL CHECK DRAWN DATE

Yangzhengguo Yangjingyi Lvtiansheng 2016/08/26

PART NO.

A2006TL-PXXX-X

TITLE

2.00mm Crimp Style Connectors

UNIT	SCALE	SHEET	REV	NUMBER
mm	1:1	1/1	A0	A-000

DATE	REV	ECN NO.	DESCRIPTION	MODIFY	APPROVAL
1					
2					
3					
4					
5					

RoHS

F

E

D

C

B

A

Last circuit

Circuit 2

Circuit 1

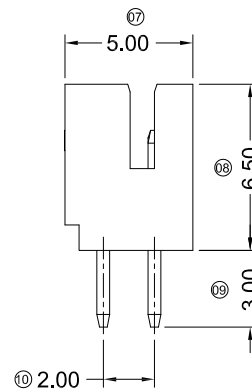
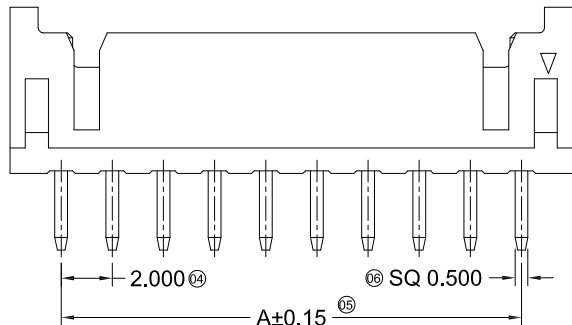
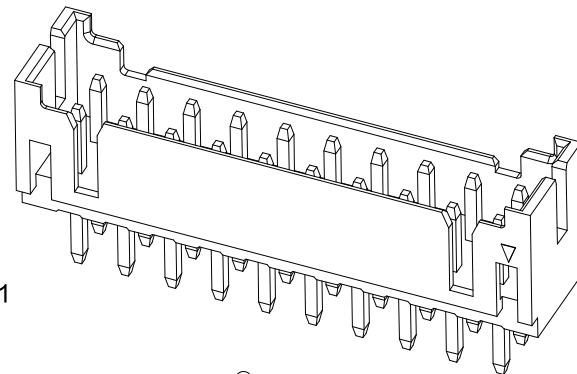
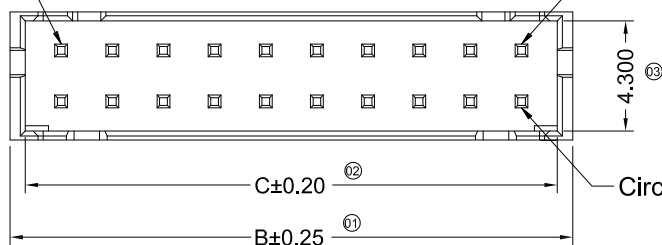

Last circuit

Circuit 2

Circuit 1

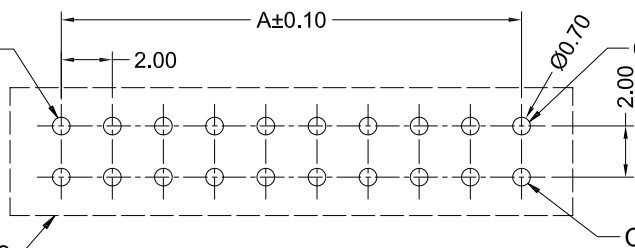

Recommended P.C.B Layout
General Tolerance±0.05

■ Specifications :

- Voltage rating: 250V AC / DC
- Current rating: 3A AC / DC
- Withstanding voltage: 800V AC/minute
- Temperature range: -25° ~+85°
- Insulation resistance: ≥1000MΩ
- Contact resistance: ≤10mΩ
- After environmental testing: ≤20mΩ
- Material(Pin): Brass
- Mates With GYA Housing : A2006H-2*XX

A2006 W V X-2*XX X -N0 XXX XX
① ② ③ ④ ⑤ ⑥ ⑦ ⑧ ⑨

- ① Series No.
- ② Category: W-Wafer
- ③ Connector type: V-Straight 180°
- ④ Mouting type: Blank-DIP
- ⑤ Row No.-Pin No.: 2*XX-2*02P~2*22P
- ⑥ Special No.: HF-Halogen Free
- ⑦ Material: N0-PA66 94V-0
- ⑧ Plating code: SN-Bright Tin Plating;
V01-Gold Flash
- ⑨ Color: Blank-Natural Color;
BK-Black; WH-White

Poles	Dimensions (mm)			Poles	Dimensions (mm)		
	A	B	C		A	B	C
2*02	2.00	6.00	4.80	2*13	24.00	28.00	26.80
2*03	4.00	8.00	6.80	2*14	26.00	30.00	28.80
2*04	6.00	10.00	8.80	2*15	28.00	32.00	30.80
2*05	8.00	12.00	10.80	2*16	30.00	34.00	32.80
2*06	10.00	14.00	12.80	2*17	32.00	36.00	34.80
2*07	12.00	16.00	14.80	2*18	34.00	38.00	36.80
2*08	14.00	18.00	16.80	2*19	36.00	40.00	38.80
2*09	16.00	20.00	18.80	2*20	38.00	42.00	40.80
2*10	18.00	22.00	20.80	2*21	40.00	44.00	42.80
2*11	20.00	24.00	22.80	2*22	42.00	46.00	44.80
2*12	22.00	26.00	24.80				



GENERAL TOLERANCE

- .X ±0.30
- .XX ±0.20
- .XXX ±0.10
- X.° ±2°

PROJECT

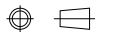

东莞市国亚电子有限公司
Dong Guan Guo Ya Connectors co., Ltd.

APPROVAL CHECK DRAWN DATE

Yangzhengguo Yangjingyi Lvtiansheng 2016/08/26

PART NO.

A2006WV-2*XX-N0XXXX

TITLE

2.00mm Crimp Style Connectors

UNIT	SCALE	SHEET	REV	NUMBER
mm	1 : 1	1/1	A0	A-053

F

E

D

C

B

A

1 2 3 4 5 6 7 8

1

2

3

4

5

6

7

8

DATE

REV

ECN NO.

DESCRIPTION

MODIFY

APPROVAL

1

2

3

4

5

6

7

8

RoHS

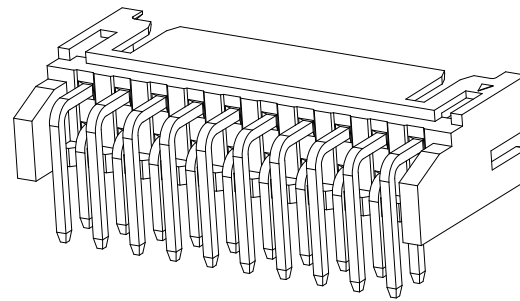
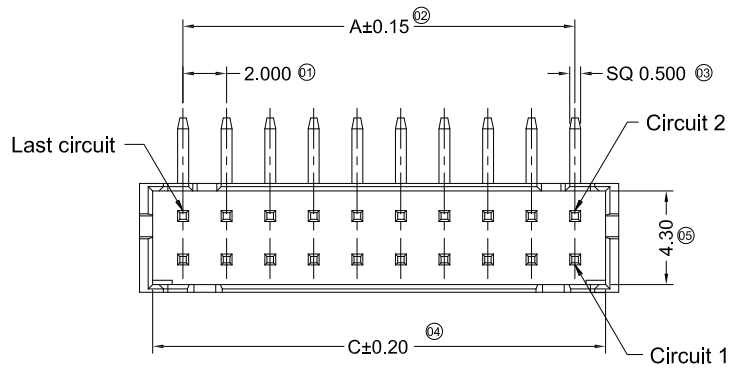

■ Specifications :

- Voltage rating: 250V AC / DC
- Current rating: 3A AC / DC
- Withstanding voltage: 800V AC/minute
- Temperature range: -25° ~+85°
- Insulation resistance: ≥1000MΩ
- Contact resistance: ≤10mΩ
- After environmental testing: ≤20mΩ
- Material(Pin): Brass
- Mates With GYA Housing : A2006H-2*XX

A2006 W R X-2*XX X -N0 XXX XX
 ① ② ③ ④ ⑤ ⑥ ⑦ ⑧ ⑨

- ① Series No.
- ② Category: W-Wafer
- ③ Connector type: R-Right Angle 90°
- ④ Mounting type: Blank-DIP
- ⑤ Row No.-Pin No.: 2*XX-2*02P~2*22P
- ⑥ Special No.: Blank-DIP=3.00mm
- ⑦ Material: N0-PA66 94V-0
- ⑧ Plating code: SN-Bright Tin
V01-All Gold Flash
- ⑨ Color : Blank-Natural Color

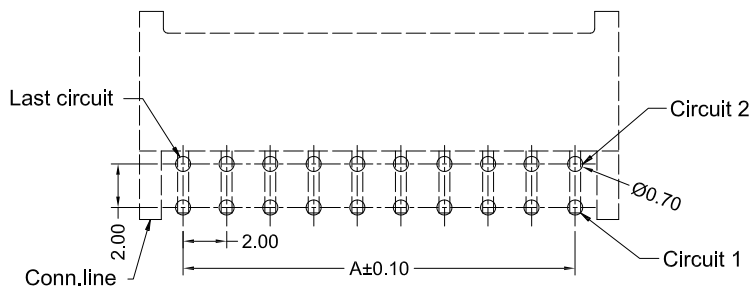
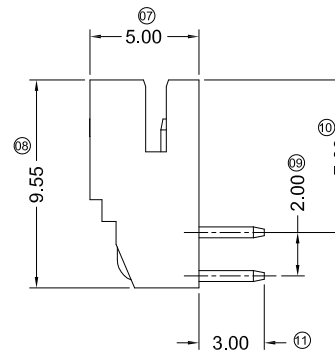
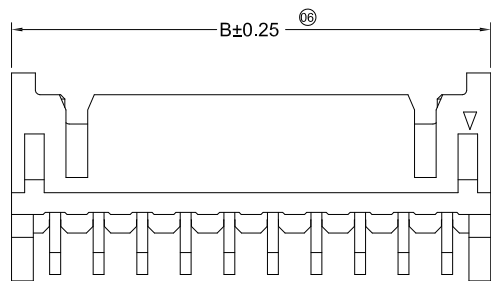

Recommended P.C.B Layout
 General Tolerance±0.05

Poles	Dimensions (mm)			Poles	Dimensions (mm)		
	A	B	C		A	B	C
2*02	2.00	6.00	4.80	2*13	24.00	28.00	26.80
2*03	4.00	8.00	6.80	2*14	26.00	30.00	28.80
2*04	6.00	10.00	8.80	2*15	28.00	32.00	30.80
2*05	8.00	12.00	10.80	2*16	30.00	34.00	32.80
2*06	10.00	14.00	12.80	2*17	32.00	36.00	34.80
2*07	12.00	16.00	14.80	2*18	34.00	38.00	36.80
2*08	14.00	18.00	16.80	2*19	36.00	40.00	38.80
2*09	16.00	20.00	18.80	2*20	38.00	42.00	40.80
2*10	18.00	22.00	20.80	2*21	40.00	44.00	42.80
2*11	20.00	24.00	22.80	2*22	42.00	46.00	44.80
2*12	22.00	26.00	24.80				



GENERAL TOLERANCE

.X ±0.30

.XX ±0.20

.XXX ±0.10

X.° ±2°

PROJECT



东莞市国亚电子有限公司
 Dong Guan Guo Ya Connectors co., ltd.

PART NO.

A2006WR-2*XX-N0XXX

TITLE

2.00mm Crimp Style Connectors

APPROVAL

Yangzhengguo

CHECK

Yangjingyi

DRAWN

Lvtiansheng

DATE

2016/08/26

UNIT

mm

SCALE

1:1

SHEET

1/1

REV

A0

NUMBER

A-053

DATE	REV	ECN NO.	DESCRIPTION	MODIFY	APPROVAL	PROJECT	APPROVAL	CHECK	DRAWN	DATE	UNIT	SCALE	SHEET	REV	NUMBER
1											mm	1:1	1/1	A0	A-053