

RoHS

04P~20P A±0.20
 22P~30P A±0.25
 32P~40P A±0.30
 42P~60P A±0.40

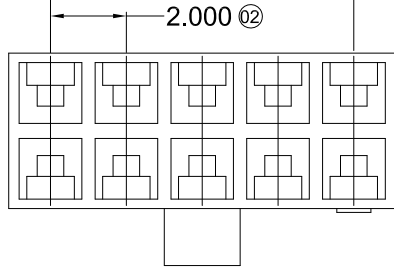

04P~20P B±0.30
 22P~30P B±0.35
 32P~40P B±0.45
 42P~60P B±0.50

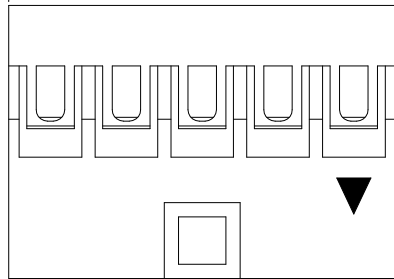

04 2.00 05 0.700 06 0.700 07 2.000

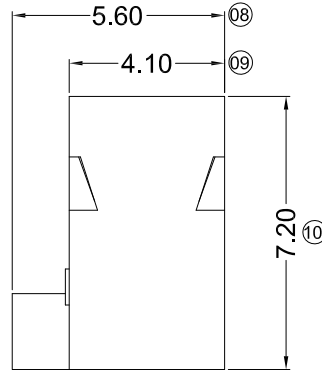
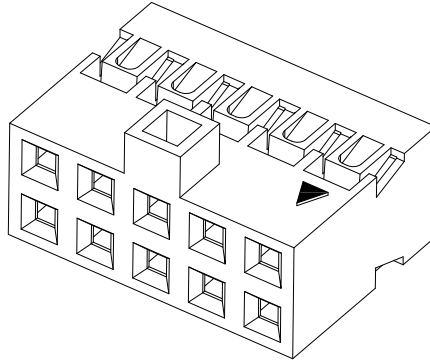
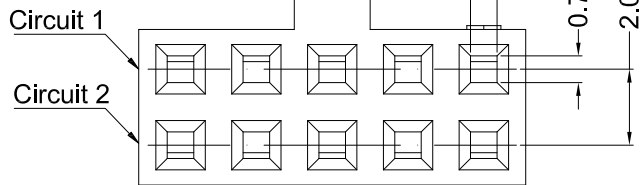

Specifications :

- Voltage rating: 250V AC / DC
- Current rating: 2A AC / DC
- Withstanding voltage: 1000V AC/minute
- Temperature range: -25° ~+85°
- Insulation resistance: ≥1000MΩ
- Contact resistance: ≤20mΩ
- After environmental testing: ≤30mΩ
- Mates With GYA Pin Heade Or Box Header 4601W
- Suitable GYA Terminal 4601T

4601 H X - 2*XX H - XX XX

① ②③ ④ ⑤ ⑥ ⑦

- ① Series No.
- ② Category: H-HSG
- ③ Appearance type: Blank-Ordinary
- ④ Row No.-Pin No.: 2*XX-2*02P~2*30P
- ⑤ Plug the Pin & special No.: H-Salient points higher
- ⑥ Material: N0-PA66 UL 94V-0; PT-PBT UL 94V-0
- ⑦ Color: Blank-Natural Color
HF-Halogen Free

Poles	Dimensions (mm)		Poles	Dimensions (mm)	
	A	B		A	B
2*02	2.00	4.20	2*14	26.00	28.20
2*03	4.00	6.20	2*15	28.00	30.20
2*04	6.00	8.20	2*16	30.00	32.20
2*05	8.00	10.20	2*17	32.00	34.20
2*06	10.00	12.20	2*18	34.00	36.20
2*07	12.00	14.20	2*19	36.00	38.20
2*08	14.00	16.20	2*20	38.00	40.20
2*09	16.00	18.20	2*21	40.00	42.20
2*10	18.00	20.20	2*22	42.00	44.20
2*11	20.00	22.20	2*23	44.00	46.20
2*12	22.00	24.20	2*24	46.00	48.20
2*13	24.00	26.20	2*25	48.00	50.20

DATE	REV	ECN NO.	DESCRIPTION	MODIFY	APPROVAL
1					
2					
3					
4					
5					

GENERAL TOLERANCE	
.X	±0.30
.XX	±0.20
.XXX	±0.10
X.°	±2°
PROJECT	



东莞市国亚电子有限公司
 Dong Guan Guo Ya Connectors co., ltd.

APPROVAL	CHECK	DRAWN	DATE
Yangzhengguo	Yangzhengyi	Lvtiansheng	2016/08/26

PART NO.				
4601H-2*XXH-XXXX				
TITLE				
2.00mm CrImp Style Connectors				
UNIT	SCALE	SHEET	REV	NUMBER
mm	1:1	1/1	A0	A-106

RoHS

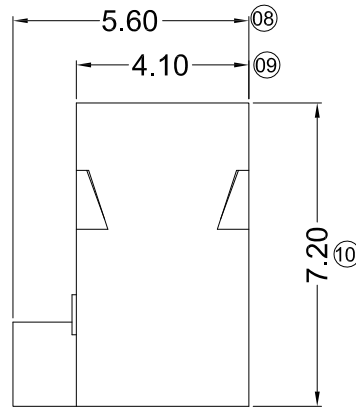
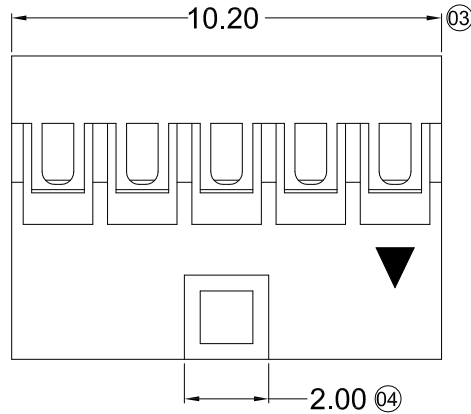
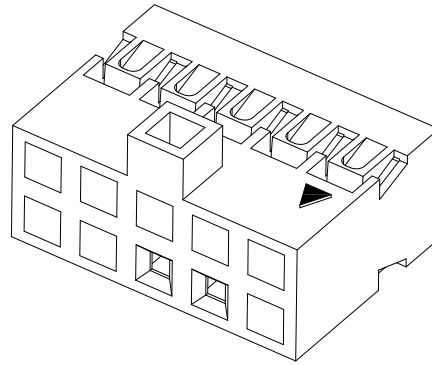
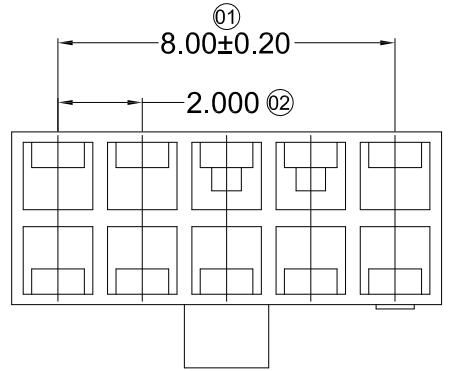

■ Specifications :

- Voltage rating: 250V AC / DC
- Current rating: 2A AC / DC
- Withstanding voltage: 1000V AC/minute
- Temperature range: -25° ~+85°
- Insulation resistance: ≥1000MΩ
- Contact resistance: ≤20mΩ
- After environmental testing: ≤30mΩ
- Suitable GYA Terminal 4601T
- Mates With GYA Pin Heade Or Box Header 4601W

4601 H X - 2*05 HK8 - XX XX

① ② ③ ④ ⑤ ⑥ ⑦

- ① Series No.
- ② Category: H-HSG
- ③ Appearance type: Blank-Ordinary
- ④ Row No.-Pin No.: 2*XX-2*02P~2*30P
- ⑤ Plug the Pin & special No. :
H-Salient points higher
K8-Plug the 1th,2th,3th,5th,7th,8th,9th,10th PIN
- ⑥ Material: N0-PA66 UL 94V-0; PT-PBT UL 94V-0
- ⑦ Color: Blank-Natural Color
HF-Halogen Free

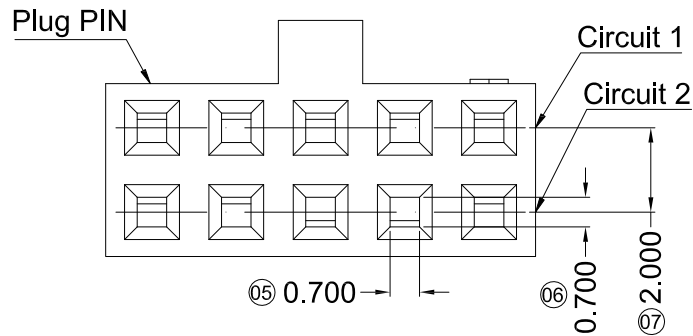

GENERAL TOLERANCE

.X	±0.30
.XX	±0.20
.XXX	±0.10
X.°	±2°



东莞市国亚电子有限公司
Dong Guan Guo Ya Connectors co., ltd.

APPROVAL CHECK DRAWN DATE

PROJECT Yangzhengguo Yangzhengyi Lviansheng 2016/08/26

PART NO.
4601H-2*05HK8-XXXX

TITLE 2.00mm CrImp Style Connectors

UNIT	SCALE	SHEET	REV	NUMBER
mm	1:1	1/1	A0	A-106

DATE	REV	ECN NO.	DESCRIPTION	MODIFY	APPROVAL
1					

RoHS

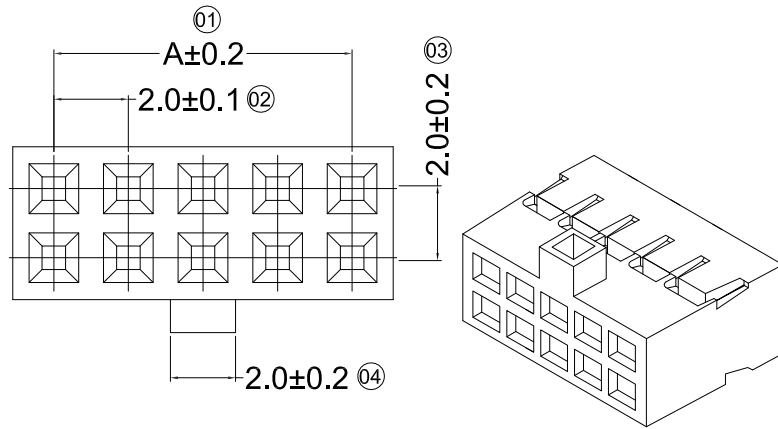

■ Specifications :

- Voltage rating: 250V AC / DC
- Current rating: 2A AC / DC
- Withstanding voltage: 1000V AC/minute
- Temperature range: -25° ~+85°
- Insulation resistance: ≥1000MΩ
- Contact resistance: ≤20mΩ
- After environmental testing: ≤30mΩ
- Suitable GYA Terminal 4601T
- Mates With GYA Wafer Pin Header Or Box Header
- Q'ty/Bag 1,000Pcs

4601 H X - 2*XX L - PT XX

① ②③ ④ ⑤ ⑥ ⑦

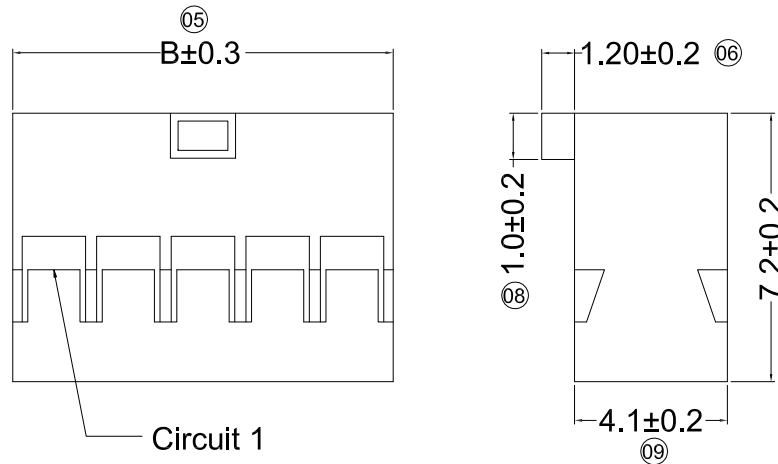

- ① Series No.
- ② Category: H-HSG
- ③ Appearance type: Blank-Ordinary
- ④ Row No.-Pin No.: 2*XX-Double Row
- ⑤ Plug the Pin & Special No.: L-Salient points Lower
- ⑥ Material: N0-PA66 94V-0 ; PT-PBT 94V-0
- ⑦ Color: Blank : Natural Color
HF-Halogen Free

Poles	Dimensions (mm)	
	A	B
04	2.00	4.20
06	4.00	6.20
08	6.00	8.20
10	8.00	10.20
12	10.00	12.20
14	12.00	14.20
16	14.00	16.20
18	16.00	18.20
20	18.00	20.20
22	20.00	22.20
24	22.00	24.20
26	24.00	26.20
28	26.00	28.20
30	28.00	30.20
32	30.00	32.20
34	32.00	34.20
36	34.00	36.20
38	36.00	38.20
40	38.00	40.20
42	40.00	42.20
44	42.00	44.20
46	44.00	46.20
48	46.00	48.20
50	48.00	50.20

				GENERAL TOLERANCE .X ±0.30 .XX ±0.20 .XXX ±0.10 X.° ±2°		GYA 东莞市国亚电子有限公司 Connectors Dong Guan Guo Ya Connectors co., ltd.			PART NO. 4601H-2*XXL-PT					
				PROJECT		APPROVAL	CHECK	DRAWN	DATE	TITLE 2.00 mm Ctrmp style Connector				
DATE	REV	ECN NO.	DESCRIPTION	MODIFY	APPROVAL	Yangzhengguo	Yangzhengyi	Lvtiansheng	2016/08/26	UNIT	SCALE	SHEET	REV	NUMBER
1										mm	1:1	1/1	A0	A-106

RoHS

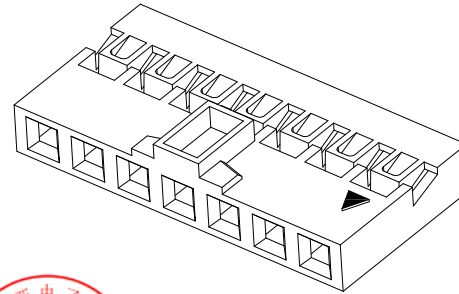
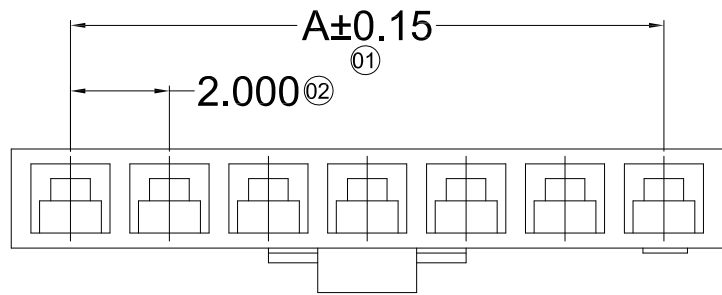

- Specifications :
- Voltage rating: 250V AC / DC
 - Current rating: 3A AC / DC
 - Withstanding voltage: 1000V AC/minute
 - Temperature range: -25° ~+85°
 - Insulation resistance: ≥1000MΩ
 - Contact resistance: ≤20mΩ
 - After environmental testing: ≤30mΩ
 - Suitable GYA Terminal: 4601T
 - Mates With GYA Pin Heade
 - Or Box Header: 4601W

4601 H X - XX A - N0 XX XX
 ① ② ③ ④ ⑤ ⑥ ⑦ ⑧

- ① Series No.
- ② Category: H-HSG
- ③ Appearance type: Blank-Ordinary
- ④ Row No.-Pin No.: XX-02P~17P
- ⑤ Special No.:
A-With Salient Point
- ⑥ Material: N0-PA66 UL 94V-0
- ⑦ Color: Blank-Natural Color ;
BK-Black
- ⑧ HF-Halogen Free

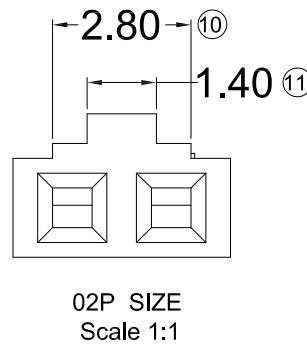
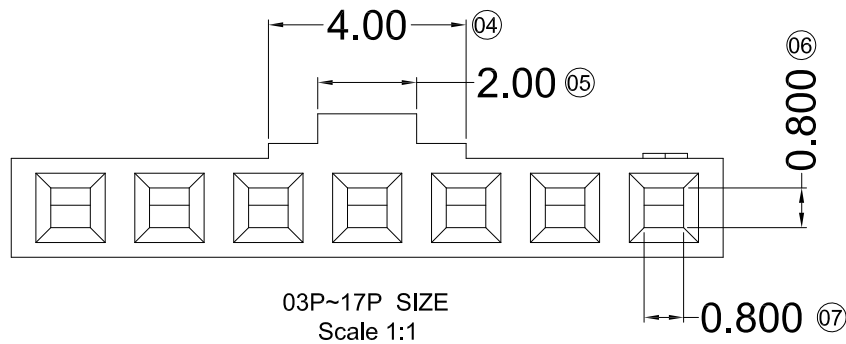
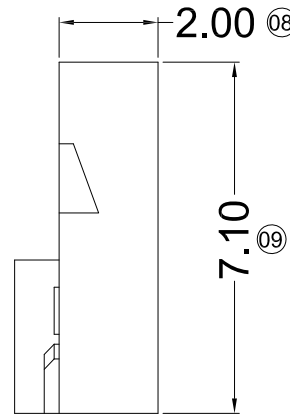
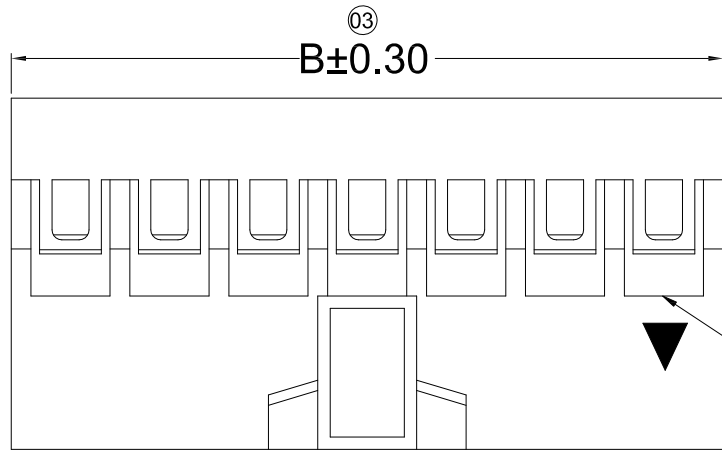

Poles	Dimensions (mm)		Poles	Dimensions (mm)	
	A	B		A	B
02	2.00	4.40	10	18.00	20.40
03	4.00	6.40	11	20.00	22.40
04	6.00	8.40	12	22.00	24.40
05	8.00	10.40	13	24.00	26.40
06	10.00	12.40	14	26.00	28.40
07	12.00	14.40	15	28.00	30.40
08	14.00	16.40	16	30.00	32.40
09	16.00	18.40	17	32.00	34.40

DATE	REV	ECN NO.	DESCRIPTION	MODIFY	APPROVAL
1					
2					
3					
4					

GENERAL TOLERANCE	
.X	±0.30
.XX	±0.20
.XXX	±0.10
X.°	±2°
PROJECT	

GYA 东莞市国亚电子有限公司
 Connectors Dong Guan Guo Ya Connectors co., ltd.

APPROVAL	CHECK	DRAWN	DATE
Yangzhengguo	Yangzhengyi	Lvtiansheng	2016/08/26

PART NO. 4601H-XXA-N0XX				
TITLE 2.00mm Crimp Style Connectors				
UNIT	SCALE	SHEET	REV	NUMBER
mm	1:1	1/1	A0	A-253

RoHS

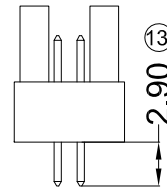
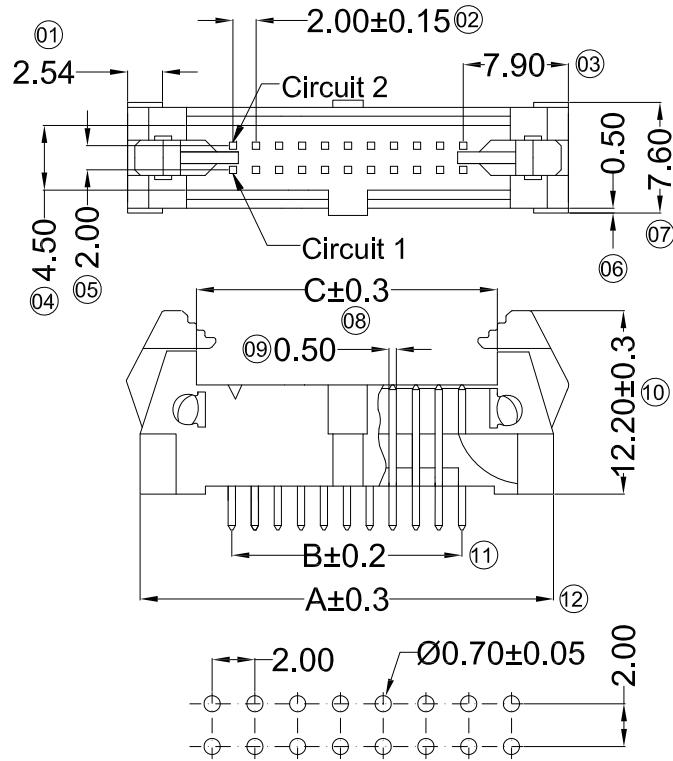

Recommand PCB Layout

Poles	Dimensions (mm)			Poles	Dimensions (mm)		
	A	B	C		A	B	C
10	23.86	8.03	14.43	30	43.86	28.03	34.43
16	29.86	14.03	20.43	34	47.86	32.03	38.43
20	33.86	18.03	24.43	40	53.86	38.03	44.43
24	37.86	22.03	28.43	44	57.86	42.03	48.43
26	39.86	24.03	30.43	50	63.86	48.03	54.43

Specifications :

- Voltage rating: 250V AC / DC
- Current rating: 2A AC / DC
- Withstanding voltage: 1000V AC/minute
- Temperature range: -25° ~+85°
- Insulation resistance: ≥1000MΩ
- Contact resistance: ≤20mΩ
- After environmental testing: ≤30mΩ
- Material(Pin) Brass
- Mates With GYA Housing 4601H

4601 K V X- 2*XX A - LP V01 XX

① ② ③ ④ ⑤ ⑥ ⑦ ⑧ ⑨

- ① Series No.
- ② Category: K-Cowfish Longhorn Connector
- ③ Welding Board Angle: V-180° ; R-90°
- ④ Welding Way: Blank-DIP ; S-SMT
- ⑤ Row No.-Pin No.: XX-Single Row ; 2*XX-Double Row
- ⑥ Plug the Pin & Special No. : A- With Lock
- ⑦ Material: LP -LCP 94V-0
- ⑧ Plating Category: G**-Gold Plated Contact
V**- All Gold-Plated
01-Gold Flash 02-2u" 03-3u"
05-5u" 10-10u" 15-15u"
SN-Bright Tin Plating (70-120u")
SN1-Bright Tin Plating (120u" Min).
0-No Plating Material
SW- Fog Tin Plating
HS-Hight temperature Tin
- ⑨ Color : Blank-Natural Color

GENERAL TOLERANCE

- .X ±0.30
- .XX ±0.20
- .XXX ±0.10
- X.° ±2°



东莞市国亚电子有限公司
Dong Guan Guo Ya Connectors co., ltd.

APPROVAL CHECK DRAWN DATE

PROJECT Yangzhengguo Yangzhengyi Lviansheng 2016/08/26

PART NO.
4601KV-2*XXA-LPV01

TITLE 2.00 mm Ctrmp Style connectors

UNIT	SCALE	SHEET	REV	NUMBER
mm	1:1	1/1	D	A-000

DATE	REV	ECN NO.	DESCRIPTION	MODIFY	APPROVAL
1					
2					
3					
4					

RoHS

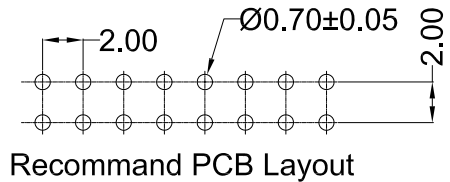
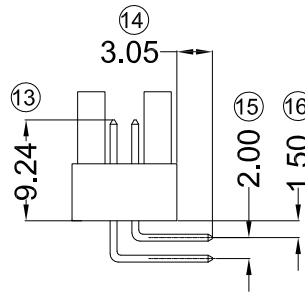
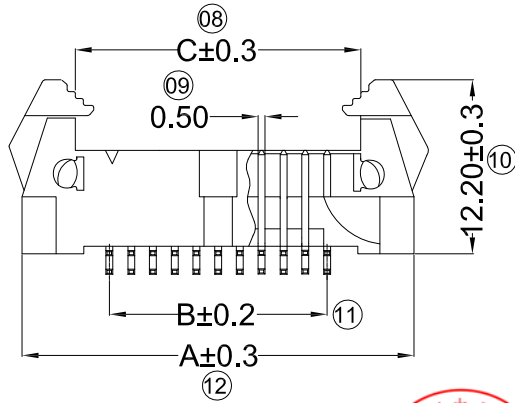
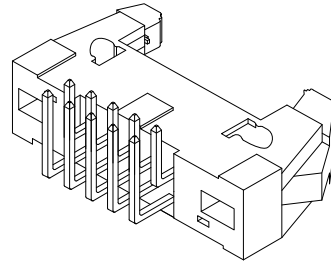
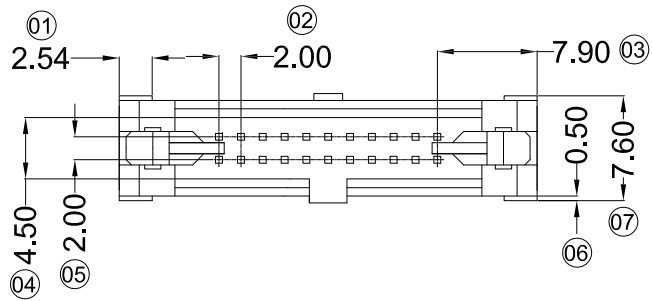

Poles	Dimensions (mm)		
	A	B	C
10	23.86	8.03	14.43
16	29.86	14.03	20.43
20	33.86	18.03	24.43
24	37.86	22.03	28.43
26	39.86	24.03	30.43
30	43.86	28.03	34.43
34	47.86	32.03	38.43
40	53.86	38.03	44.43
44	57.86	42.03	48.43
50	63.86	48.03	54.43

■ Specifications :

- Voltage rating: 250V AC / DC
- Current rating: 2A AC / DC
- Withstanding voltage: 1000V AC/minute
- Temperature range: -25° ~+85°
- Insulation resistance: ≥1000MΩ
- Contact resistance: ≤20mΩ
- After environmental testing: ≤30mΩ
- Material(Pin) Brass
- Mates With GYA Housing 4601H

4601 K R X - 2*XX A - 6T V01 XX

- ① Series No.
- ② Category: K-Cowfish Longhorn Connector
- ③ Welding Board Angle: V-180° ; R-90°
- ④ Welding Way: Blank-DIP ; S-SMT
- ⑤ Row No.-Pin No.: XX-Single Row ; 2*XX-Double Row
- ⑥ Plug the Pin & Special No. : A-With Lock
- ⑦ Material: 6T -PA6T 94V-0
- ⑧ Plating Category: G**-Gold Plated Contact
 V**- All Gold-Plated
 01-Gold Flash 02-2u" 03-3u"
 05-5u" 10-10u" 15-15u"
 SN-Bright Tin Plating (70-120u")
 SN1-Bright Tin Plating (120u" Min).
 0-No Plating Material
 SW- Fog Tin Plating
 HS-Hight temperature Tin
- ⑨ Color : Blank-Natural Color

				GENERAL TOLERANCE				GYA 东莞市国亚电子有限公司 Dong Guan Guo Ya Connectors co., ltd.				PART NO. 4601KR-2*XXA-6TV01				
				.X ±0.30								APPROVAL				TITLE 2.00 mm Ctrmp Style connectors
				.XX ±0.20				CHECK				UNIT				
				.XXX ±0.10				DRAWN				SCALE				
				X.° ±2°				DATE				SHEET				
DATE				REV				PROJECT				REV				
ECN NO.				DESCRIPTION				Yangzhengguo				NUMBER				
MODIFY				APPROVAL				Yangzhengyi				A0				
								Lviansheng				A-071				
								2016/08/26								