

RoHS

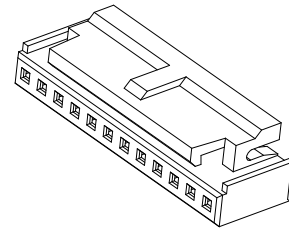
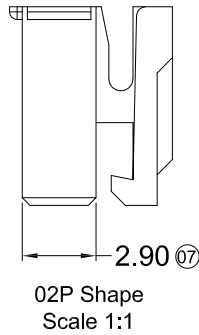
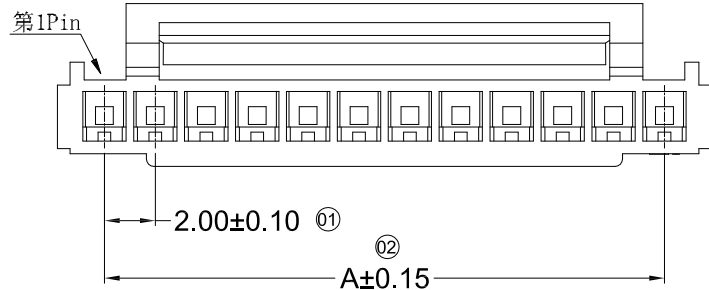

■ Specifications :

- Voltage rating: 250V AC / DC
- Current rating: 3A AC / DC
- Withstanding voltage: 1000V AC/minute
- Temperature range: -25° ~+85°
- Insulation resistance: ≥1000MΩ
- Contact resistance: ≤30mΩ
- After environmental testing: ≤40mΩ
- Suitable GYA Terminal: 2011T-A
- Mates With GYA Wafer: 2011W-A

2011 H X - XX A - N0 XX XX
① ② ③ ④ ⑤ ⑥ ⑦ ⑧

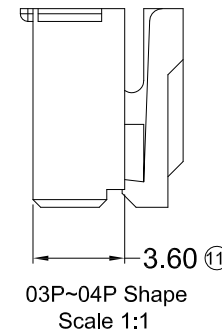
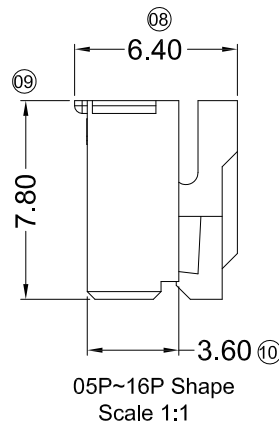
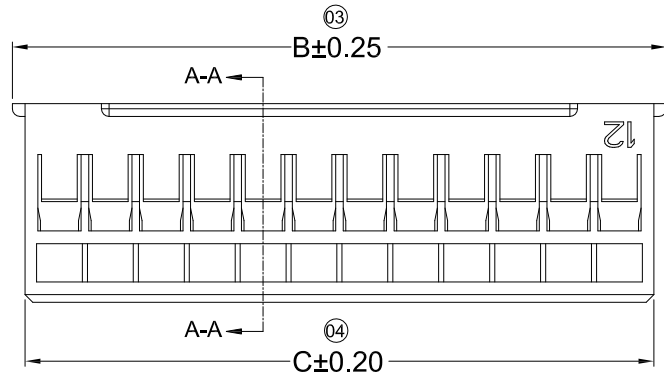

- ① Series No.
- ② Category: H-HSG
- ③ Appearance type: Blank-Ordinary
- ④ Row No.-Pin No Per Row: XX-02P~16P
- ⑤ Plug the Pin & Special No.: A-With Lock
- ⑥ Plastic material: N0-PA66 UL 94V-0
- ⑦ Color : Blank-Natural Color
BK-Black
- ⑧ Whether containing halogen:
HF-Halogen free
Blank-Containing halogen

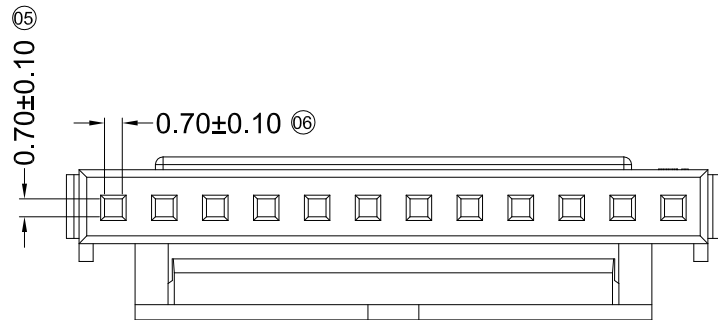

Poles	Dimensions (mm)			Poles	Dimensions (mm)		
	A	B	C		A	B	C
02	2.00	5.70	4.70	09	16.00	19.60	18.70
03	4.00	7.70	6.70	10	18.00	21.70	20.70
04	6.00	9.70	8.70	11	20.00	23.70	22.70
05	8.00	11.70	10.70	12	22.00	25.70	24.70
06	10.00	13.70	12.70	13	24.00	27.70	26.70
07	12.00	15.70	14.70	14	26.00	29.70	28.70
08	14.00	17.70	16.70				

					GENERAL TOLERANCE .X ±0.30 .XX ±0.20 .XXX ±0.10 X.° ±2°				GYA 东莞市国亚电子有限公司 Connectors Dong Guan Guo Ya Connectors co., Ltd.				PART NO. 2011H-XXA-N0XX			
					PROJECT 				APPROVAL Yangzhengguo Yangzhengyi Lviansheng 2016/08/26				TITLE 2.00mm Crimp Style Connector			
DATE	REV	ECN NO.	DESCRIPTION	MODIFY	APPROVAL	UNIT	SCALE	SHEET	REV	NUMBER						
1	2	3	4	5	6	mm	1:1	1/1	A0	A-022						

RoHS

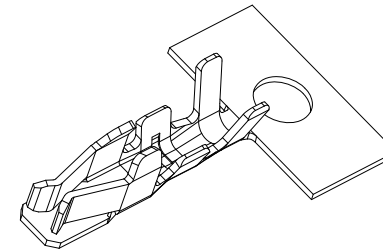

■ Specifications :

- Voltage rating: 250V AC / DC
- Current rating: 3A AC / DC
- Withstanding voltage: 1000V AC/minute
- Temperature range: -25° ~+85°
- Insulation resistance: ≥1000MΩ
- Contact resistance: ≤30mΩ
- After environmental testing: ≤40mΩ

2011 T X - P XX X - AX

① ②③ ④ ⑤⑥ ⑦

- ① Series Number
- ② Category: T-terminal
- ③ Shape: Blank-ordinary L-Lower Crimp
- ④ Material: P-Phosphor bronze
- ⑤ Plating Code: SN-Bright tin plating
G01-Contact Gold flash
- ⑥ Plating method: Blank-Stamping before plating
- ⑦ Mold No./Mark/Special No. :
A-Mating 2011-A HSG、
A1-Mating 2011-A HSG、

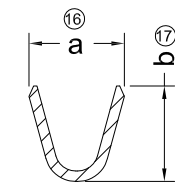
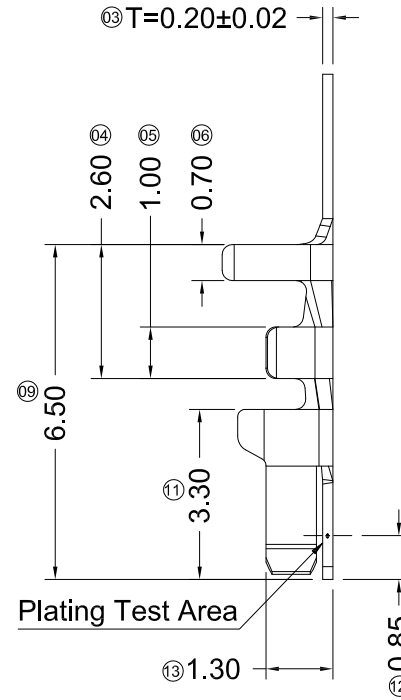
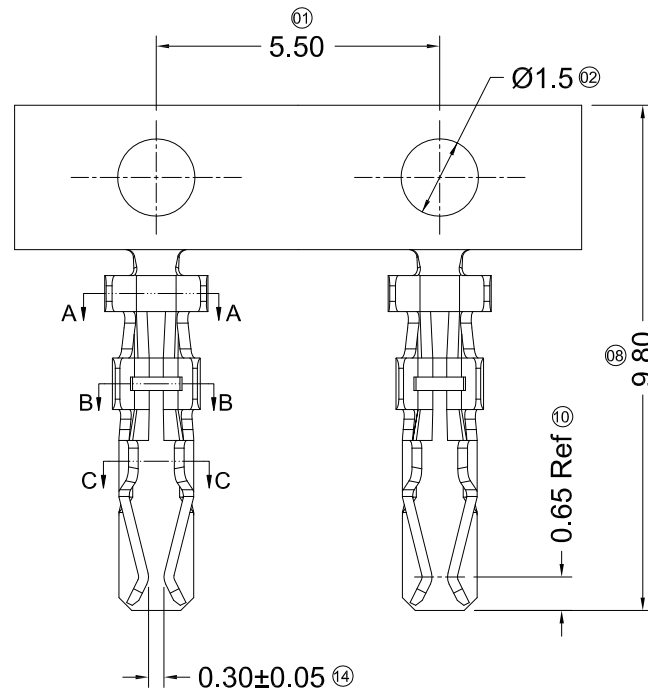

SECTION A-A
SCALE 1:1

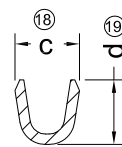

SECTION B-B
SCALE 1:1

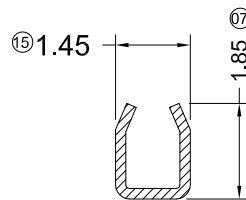

SECTION C-C
SCALE 1:1

2011T-PG01-A	Phosphor Bronze	22-28 AWG	1.45mm(Max)	2.00	2.20	1.70	1.30	2011H-A
2011T-PSN-A		26-28 AWG	1.00mm(Max)	1.85	1.85	1.25	1.25	
2011TL-PG01-AX								
2011TL-PSN-AX								
PART NO	Material	Wire Range	Insulation O.D.	DIM a	DIM b	DIM c	DIM d	Used In GYA Housing

DATE	REV	ECN NO.	DESCRIPTION	MODIFY	APPROVAL
1	2	3	4	5	6

GENERAL TOLERANCE
.X ±0.30
.XX ±0.20
.XXX ±0.10
X.° ±2°
PROJECT
Yangzhengguo



东莞市国亚电子有限公司
Dong Guan Guo Ya Connectors co., Ltd.

APPROVAL	CHECK	DRAWN	DATE
Yangzhengyi	Yangzhengyi	Lvliansheng	2016/08/26

PART NO. 2011TX-PXX-AX				
TITLE 2.00mm Crimp Style Connectors				
UNIT	SCALE	SHEET	REV	NUMBER
mm	1:1	1/1	A0	A-014

RoHS

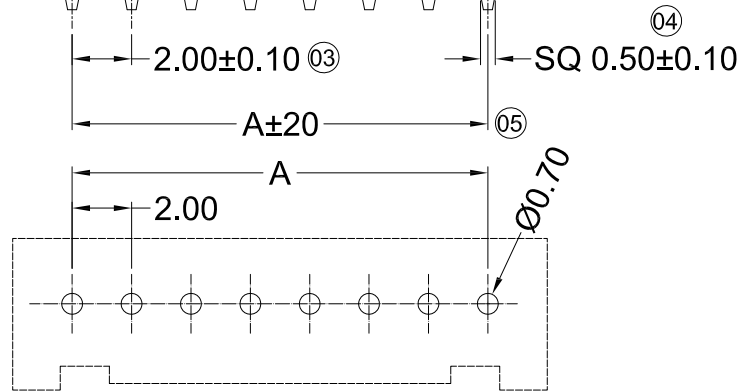
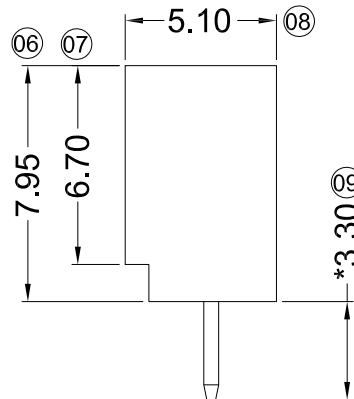
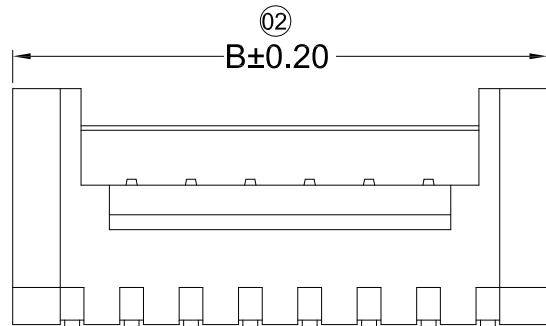
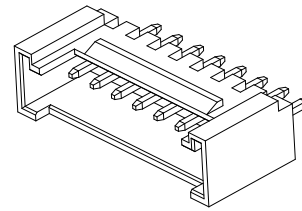
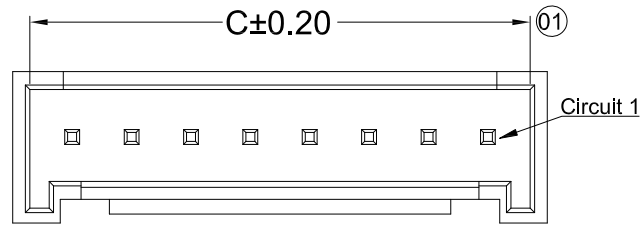

Conn.line
Recommended P.C.B Layout
General Tolerance±0.05

■ Specifications :

- Voltage rating: 250V AC / DC
- Current rating: 3A AC / DC
- Withstanding voltage: 1000V AC/minute
- Temperature range: -25° ~+85°
- Insulation resistance: ≥1000MΩ
- Contact resistance: ≤30mΩ
- After environmental testing: ≤40mΩ
- Material(Pin): Brass
- Mates With GYA Housing : 2011H-A

2011 W V X - XX A HF - XX XX XX
① ② ③ ④ ⑤ ⑥ ⑦ ⑧ ⑨ ⑩

- ① Series No.
- ② Category: W-WAFER
- ③ Connector Type: V-Straight 180°
- ④ Mounting Type: Blank-DIP
- ⑤ Row No.-Pin No.: XX-02P~16P
- ⑥ Plug the Pin & Special No.: A-Without Baffle
- ⑦ HF-Halogen Free ; Blank-ROHS
- ⑧ Serial: N0 -PA66 UL 94V-0
- ⑨ Plating Code: SN-Bright Tin Plating
V01-Gold Flash
V05-Gold-Plating 5u "
- ⑩ Color : Blank-Natural Color
BE-Beige Color



Poles	Dimensions (mm)			Poles	Dimensions (mm)		
	A	B	C		A	B	C
02	2.00	6.00	4.85	10	18.00	22.00	20.85
03	4.00	8.00	6.85	11	20.00	24.00	22.85
04	6.00	10.00	8.85	12	22.00	26.00	24.85
05	8.00	12.00	10.85	13	24.00	28.00	26.85
06	10.00	14.00	12.85	14	26.00	30.00	28.85
07	12.00	16.00	14.85	15	28.00	32.00	30.85
08	14.00	18.00	16.85	16	30.00	34.00	32.85
09	16.00	20.00	18.85				

						GENERAL TOLERANCE .X ±0.30 .XX ±0.20 .XXX ±0.10 X.° ±2°				GYA 东莞市国亚电子有限公司 Dong Guan Guo Ya Connectors co., Ltd.				PART NO. 2011WV-XXAXX-N0XXXX												
						APPROVAL Yangzhengguo				CHECK Yangzhengyi				DRAWN Lviansheng				DATE 2016/08/26				TITLE 2.00mm Crimp Style Connectors				
PROJECT 																		UNIT SCALE SHEET REV NUMBER mm 1:1 1/1 A0 A-000								
DATE	REV	ECN NO.	DESCRIPTION	MODIFY	APPROVAL																					

RoHS

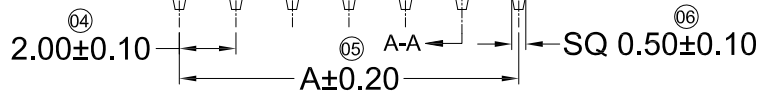
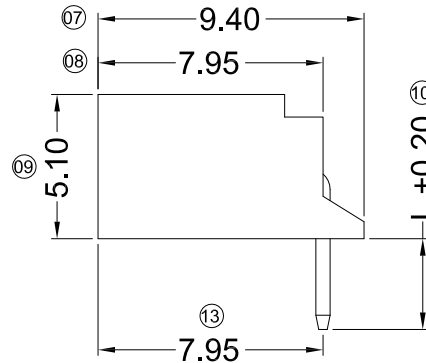
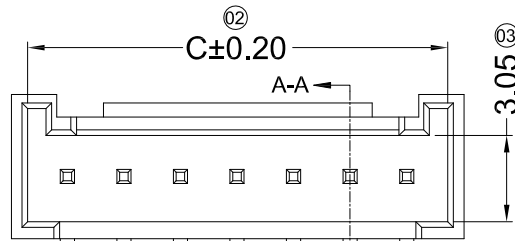
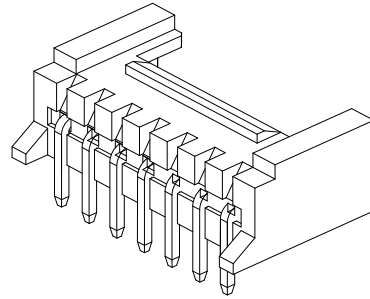
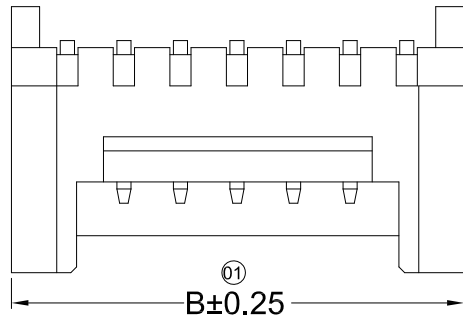

Specifications :

- Voltage rating: 250V AC / DC
- Current rating: 3A AC / DC
- Withstanding voltage: 1000V AC/minute
- Temperature range: -25° ~+85°
- Insulation resistance: ≥1000MΩ
- Contact resistance: ≤30mΩ
- After environmental testing: ≤40mΩ
- Material(Pin): Brass
- Mates With GYA Housing : 2011H-A

2011 W R X - XX A HF - N0 SN XX

① ② ③ ④ ⑤ ⑥ ⑦ ⑧ ⑨

① Series No.

② Category: W-WAFER

③ Welding Board Angle : R-Right Angle 90°

④ Welding Way: Blank-DIP

⑤ Row No.-Pin No.: XX-02P~16P

⑥ Special No.:

A-With Link Stopper DIP-3.20mm

A2-With Link Stopper DIP-2.50mm

A3-With Link Stopper DIP-1.50mm

⑦ HF-Halogen Free ; Blank-ROHS

⑧ Material: N0 -PA66 UL 94V-0

⑨ Plating Category: SN-Bright Tin Plating
V01-Gold Flash

Color : Blank-Natural Color

BE-Beige Color

Poles	Dimensions (mm)			Poles	Dimensions (mm)		
	A	B	C		A	B	C
02	2.00	6.00	4.85	10	18.00	22.00	20.85
03	4.00	8.00	6.85	11	20.00	24.00	22.85
04	6.00	10.00	8.85	12	22.00	26.00	24.85
05	8.00	12.00	10.85	13	24.00	28.00	26.85
06	10.00	14.00	12.85	14	26.00	30.00	28.85
07	12.00	16.00	14.85	15	28.00	32.00	30.85
08	14.00	18.00	16.85	16	30.00	34.00	32.85
09	16.00	20.00	18.85				

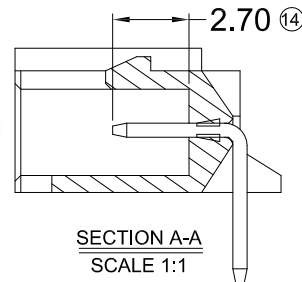
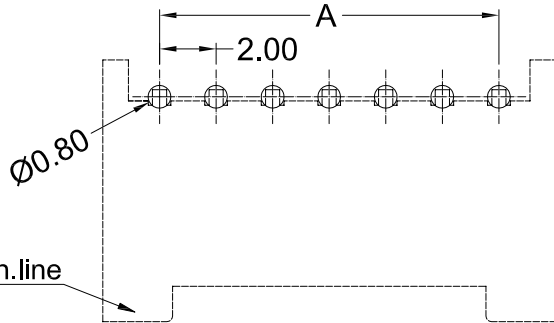

Conn.line

Recommended P.C.B Layout T=1.6mm
General Tolerance±0.05

SECTION A-A
SCALE 1:1

GENERAL TOLERANCE						APPROVAL				PART NO.					
.X ±0.30						GYA 东莞市国亚电子有限公司 Connectors Dong Guan Guo Ya Connectors co., Ltd.				2011WR-XXAXX-N0XXXX					
.XX ±0.20										TITLE 2.00mm Crimp Style Connector					
.XXX ±0.10										UNIT SCALE SHEET REV NUMBER					
X.° ±2°										mm 1:1 1/1 A0 A-000					
DATE	REV	ECN NO.	DESCRIPTION	MODIFY	APPROVAL	PROJECT	Yangzhengguo	Yangzhengyi	Lvtiansheng	2016/06/28					

RoHS

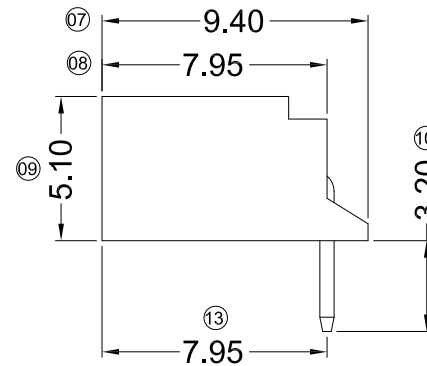
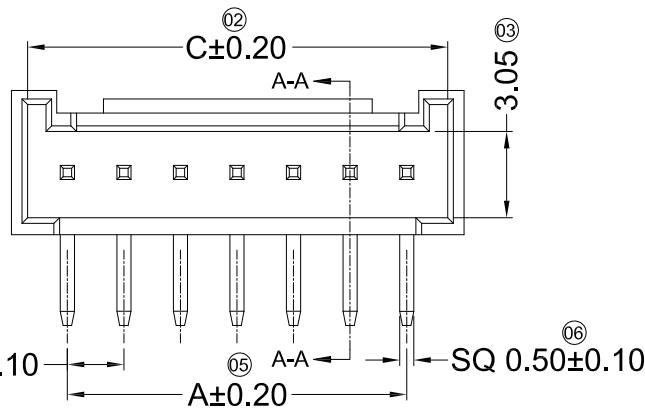
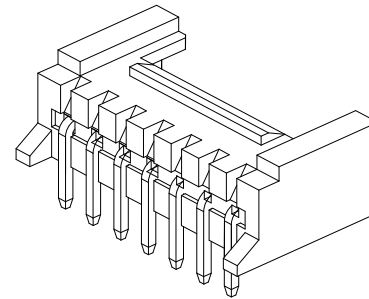
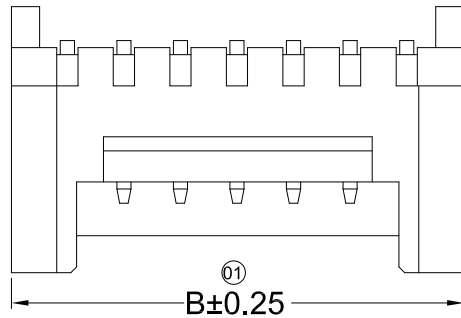

Specifications :

- Voltage rating: 250V AC / DC
- Current rating: 3A AC / DC
- Withstanding voltage: 1000V AC/minute
- Temperature range: -25° ~+85°
- Insulation resistance: ≥1000MΩ
- Contact resistance: ≤30mΩ
- After environmental testing: ≤40mΩ
- Material(Pin): Brass
- Mates With GYA Housing : 2011H-A

2011 W R X - XX A4 - N0 SN XX
 ① ②③④ ⑤ ⑥ ⑦ ⑧ ⑨

- ① Series No.
- ② Category: W-WAFER
- ③ Welding Board Angle : R-Right Angle 90°
- ④ Welding Way: Blank-DIP
- ⑤ Row No.-Pin No.: XX-02P~16P
- ⑥ Special No.:
 A4-With Link Stopper DIP-3.20mm
 Inside groove 2.70mm
- ⑦ Material: N0 -PA66 UL 94V-0
- ⑧ Plating Category: SN-Bright Tin Plating
- ⑨ Color : Blank-Natural Color

Poles	Dimensions (mm)			Poles	Dimensions (mm)		
	A	B	C		A	B	C
02	2.00	6.00	4.85	10	18.00	22.00	20.85
03	4.00	8.00	6.85	11	20.00	24.00	22.85
04	6.00	10.00	8.85	12	22.00	26.00	24.85
05	8.00	12.00	10.85	13	24.00	28.00	26.85
06	10.00	14.00	12.85	14	26.00	30.00	28.85
07	12.00	16.00	14.85	15	28.00	32.00	30.85
08	14.00	18.00	16.85	16	30.00	34.00	32.85
09	16.00	20.00	18.85				

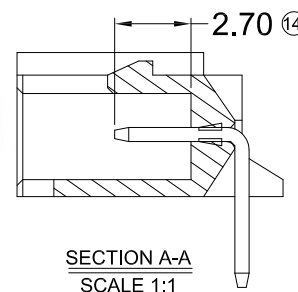
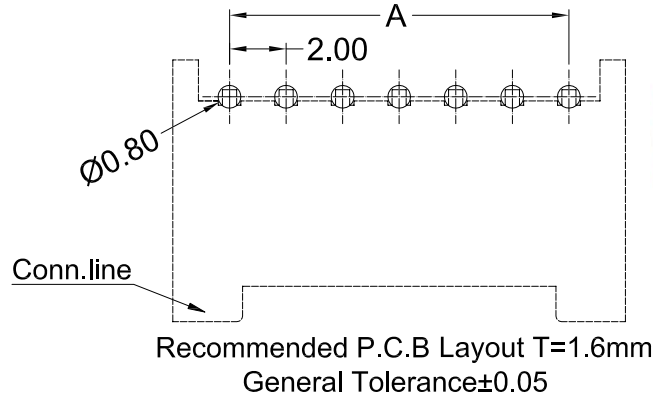

DATE	REV	ECN NO.	DESCRIPTION	MODIFY	APPROVAL
1					
2					
3					
4					

GENERAL TOLERANCE	
.X	±0.30
.XX	±0.20
.XXX	±0.10
X.°	±2°
PROJECT	
①	②



东莞市国亚电子有限公司
 Dong Guan Guo Ya Connectors co., Ltd.

APPROVAL	CHECK	DRAWN	DATE
Yangzhengguo	Yangzhengyi	Lvtiansheng	2016/08/26

PART NO.				
2011WR-XXA4-N0SN				
TITLE				
2.00mm Crimp Style Connector				
UNIT	SCALE	SHEET	REV	NUMBER
mm	1:1	1/1	A0	A-000

RoHS

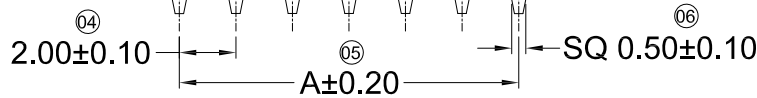
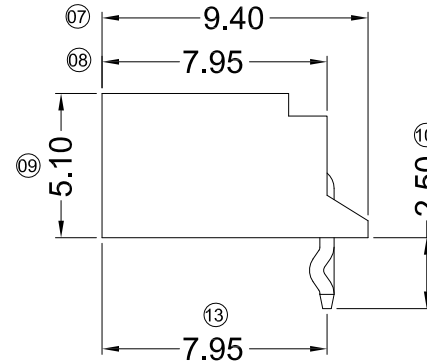
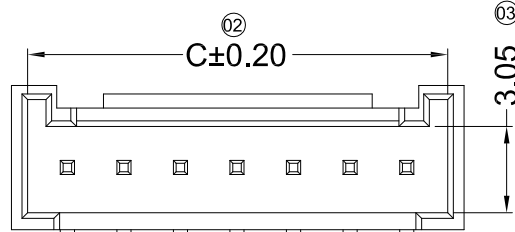
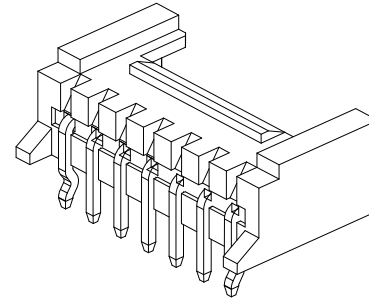
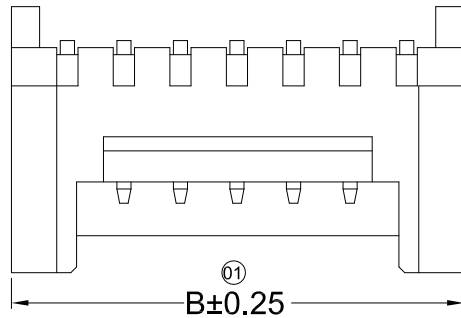

■ Specifications :

- Voltage rating: 250V AC / DC
- Current rating: 3A AC / DC
- Withstanding voltage: 1000V AC/minute
- Temperature range: -40° ~ +105°
- Insulation resistance: ≥1000MΩ
- Contact resistance: ≤30mΩ
- After environmental testing: ≤40mΩ
- Material(Pin): Brass
- Mates With GYA Housing : 2011H

2011 W R X - XX KA2 - N0 SN XX
 ① ② ③ ④ ⑤ ⑥ ⑦ ⑧ ⑨

- ① Series No.
- ② Category: W-WAFER
- ③ Connector Type: R-Right Angle 90°
- ④ Welding Way: Blank-DIP
- ⑤ Row No.-Pin No Per Row: XX-02P~16P
- ⑥ Special No.:
KA2-With Kink And Link Stopper DIP-2.50mm
- ⑦ Plastic material: N0 -PA66 UL 94V-0
- ⑧ Plating Code: SN-Bright Tin Plating
- ⑨ Color : Blank-Natural Color

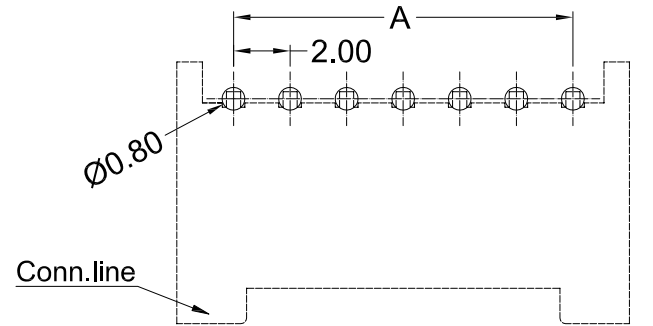

Recommended P.C.B Layout T=1.6mm
 General Tolerance±0.05



Poles	Dimensions (mm)			Poles	Dimensions (mm)		
	A	B	C		A	B	C
02	2.00	6.00	4.85	10	18.00	22.00	20.85
03	4.00	8.00	6.85	11	20.00	24.00	22.85
04	6.00	10.00	8.85	12	22.00	26.00	24.85
05	8.00	12.00	10.85	13	24.00	28.00	26.85
06	10.00	14.00	12.85	14	26.00	30.00	28.85
07	12.00	16.00	14.85	15	28.00	32.00	30.85
08	14.00	18.00	16.85	16	30.00	34.00	32.85
09	16.00	20.00	18.85				

						GENERAL TOLERANCE .X ±0.30 .XX ±0.20 .XXX ±0.10 X.° ±2°				GYA 东莞市国亚电子有限公司 Connectors Dong Guan Guo Ya Connectors co., Ltd.				PART NO. 2011WR-07KA2-N0SN				
						APPROVAL CHECK DRAWN DATE Yangzhengguo Yangzhengyi Lviansheng 2016/08/26				TITLE 2.00mm Crimp Style Connectors								
DATE	REV	ECN NO.	DESCRIPTION	MODIFY	APPROVAL	PROJECT	UNIT	SCALE	SHEET	REV	NUMBER							
1	2	3	4	5	6	7	mm	1:1	1/1	A0	A-000							

RoHS

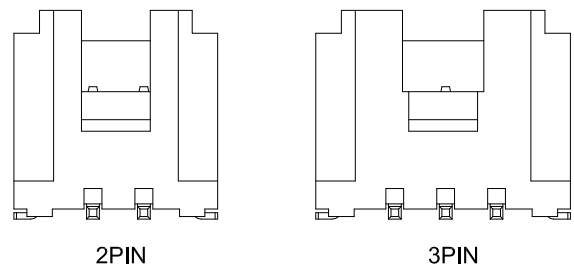
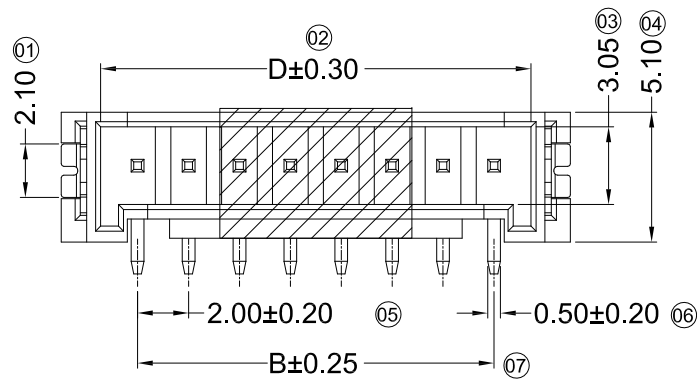

- Specifications :**
- Voltage rating: 250V AC / DC
 - Current rating: 3A AC / DC
 - Withstanding voltage: 1000V AC/minute
 - Temperature range: -25° ~+85°
 - Insulation resistance: ≥1000MΩ
 - Contact resistance: ≤30mΩ
 - After environmental testing: ≤40mΩ
 - Mates With GYA Housing : 2011H-A



2011 W V S - XX A - LP SN XX
 ① ②③④ ⑤ ⑥ ⑦ ⑧ ⑨

- ① Series No.
- ② Category: W-WAFER
- ③ Welding Board Angle: V-Straight 180°
- ④ Welding Way: S-SMT
- ⑤ Row No.-Pin No.: XX-02P~16P
- ⑥ Plug the Pin & Special No.: A-With Located Block
- ⑦ Material: LP -LCP UL 94V-0
- ⑧ Plating Category: SN-Bright Tin Plating
- ⑨ Color : Blank-Natural Color

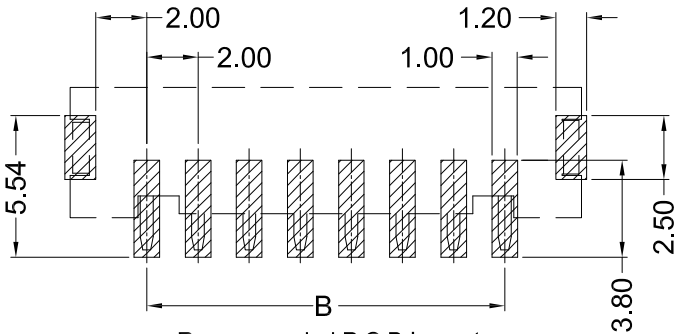
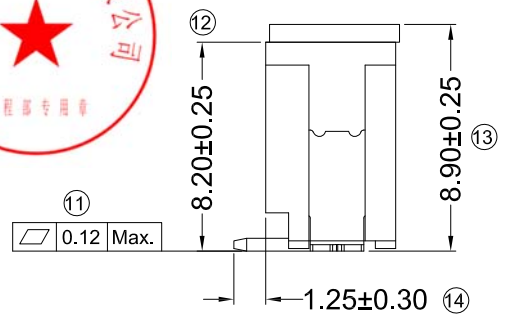
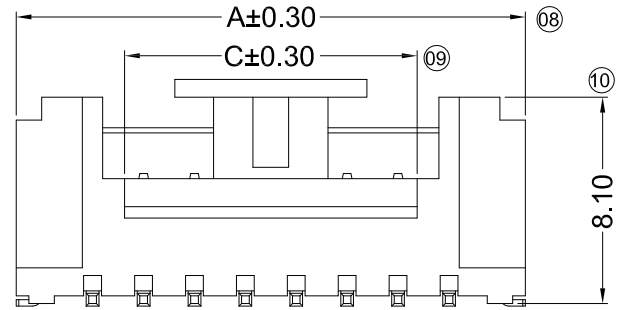

Recommended P.C.B Layout
 General Tolerance±0.05

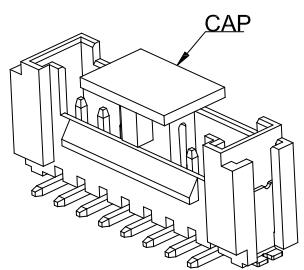

Poles	Dimensions (mm)				Poles	Dimensions (mm)			
	A	B	C	D		A	B	C	D
02	8.00	2.00	2.70	4.90	10	24.00	18.00	15.50	20.90
03	10.00	4.00	2.70	6.90	11	26.00	20.00	15.50	22.90
04	12.00	6.00	3.50	8.90	12	28.00	22.00	15.50	24.90
05	14.00	8.00	5.50	10.90	13	30.00	24.00	15.50	26.90
06	16.00	10.00	7.50	12.90	14	32.00	26.00	15.50	28.90
07	18.00	12.00	9.50	14.90	15	34.00	28.00	15.50	30.90
08	20.00	14.00	11.50	16.90	16	36.00	30.00	15.50	32.90
09	22.00	16.00	13.50	18.90					

DATE	REV	ECN NO.	DESCRIPTION	MODIFY	APPROVAL
1					
2					
3					
4					
5					

GENERAL TOLERANCE	
.X	±0.30
.XX	±0.20
.XXX	±0.10
X.°	±2°
PROJECT	

GYA 东莞市国亚电子有限公司
 Connectors Dong Guan Guo Ya Connectors co., Ltd.

APPROVAL	CHECK	DRAWN	DATE
Yangzhengguo	Yangzhengyi	Lvtiansheng	2016/08/26

PART NO. 2011WVS-XXA-LPSN				
TITLE 2.00mm Crimp Style Connector				
UNIT	SCALE	SHEET	REV	NUMBER
mm	1:1	1/1	A0	A-084

RoHS

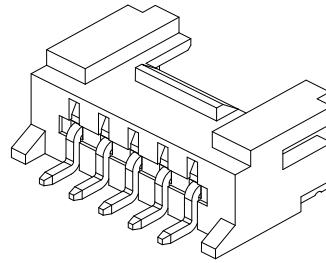
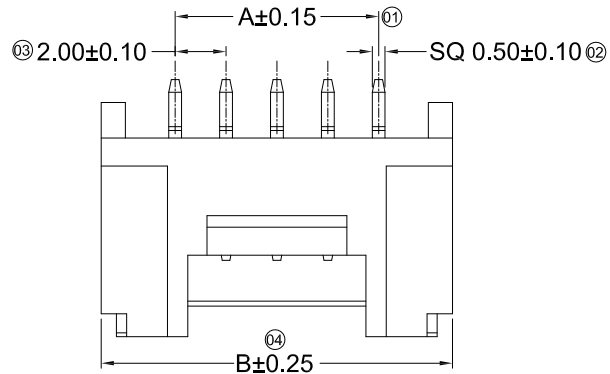

- Specifications :
- Voltage rating: 250V AC / DC
 - Current rating: 3A AC / DC
 - Withstanding voltage: 1000V AC/minute
 - Temperature range: -25° ~+85°
 - Insulation resistance: ≥1000MΩ
 - Contact resistance: ≤30mΩ
 - After environmental testing: ≤40mΩ
 - Material(Pin): Brass
 - Mates With GYA Housing : 2011H-A

2011 WRS - XX A - LP SN XX
 ① ② ③ ④ ⑤ ⑥ ⑦ ⑧ ⑨

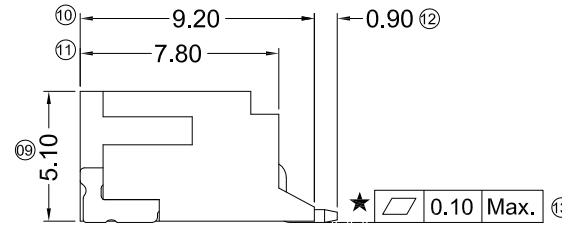

- ① Series No.
- ② Category: W-WAFER
- ③ Connector Type: R-Right Angle 90°
- ④ Mounting Type: S-SMT
- ⑤ Row No.-Pin No Per Row: XX-02P~16P
- ⑥ Special No.: A-With Located Block
- ⑦ Plastic material: LP -LCP UL 94V-0
- ⑧ Plating Code: SN-Bright Tin Plating
- ⑨ Color : Blank-Natural Color

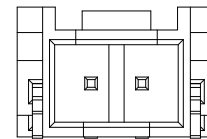
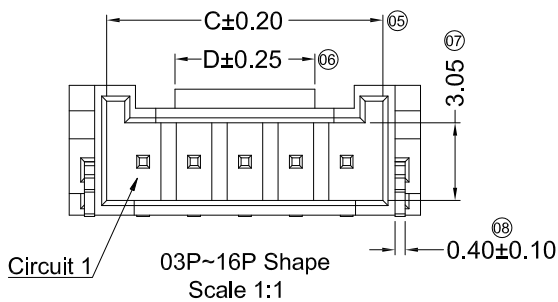

02P Shape
Scale 1:1

Poles	Dimensions (mm)				Poles	Dimensions (mm)			
	A	B	C	D		A	B	C	D
02	2.00	7.80	4.85	2.70	10	18.00	23.80	20.85	15.50
03	4.00	9.80	6.85	3.20	11	20.00	25.80	22.85	15.50
04	6.00	11.80	8.85	3.50	12	22.00	27.80	24.85	15.50
05	8.00	13.80	10.85	5.50	13	24.00	29.80	26.85	15.50
06	10.00	15.80	12.85	7.50	14	26.00	31.80	28.85	15.50
07	12.00	17.80	14.85	9.50	15	28.00	33.80	30.85	15.50
08	14.00	19.80	16.85	11.50	16	30.00	35.80	32.85	15.50
09	16.00	21.80	18.85	13.50					

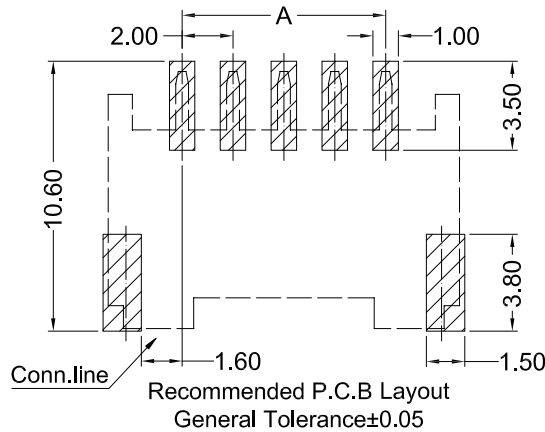

					GENERAL TOLERANCE .X ±0.30 .XX ±0.20 .XXX ±0.10 X.° ±2°				GYA 东莞市国亚电子有限公司 Dong Guan Guo Ya Connectors co., Ltd.				PART NO. 2011WRS-XXA-LPSN				
					PROJECT Yangzhengguo Yangzhengyi Lviliansheng				APPROVAL CHECK DRAWN DATE Yangzhengguo Yangzhengyi Lviliansheng 2016/08/26				TITLE 2.00mm Crimp Style Connector				
DATE	REV	ECN NO.	DESCRIPTION	MODIFY	APPROVAL	UNIT	SCALE	SHEET	REV	NUMBER							
1	2	3	4	5	6	7	8	9	10	11	mm	1:1	1/1	A0	A-084		

RoHS

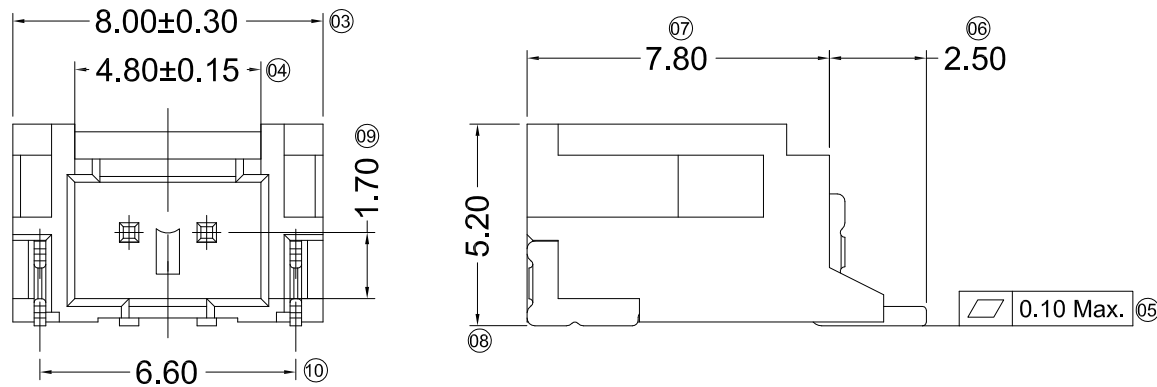
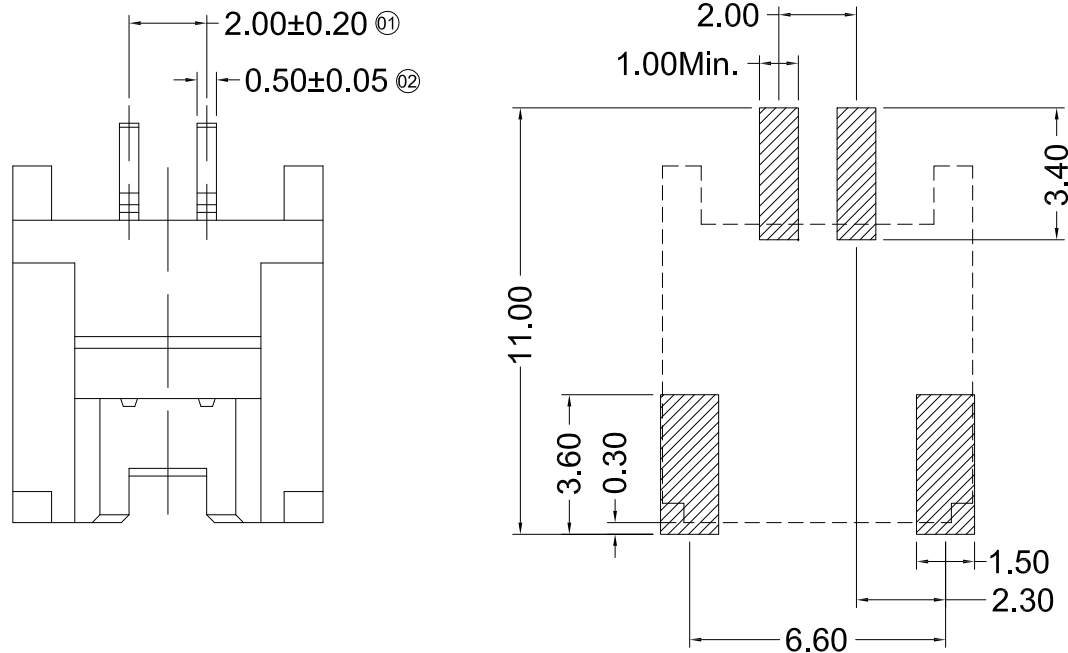

Specifications :

- Voltage rating: 125V AC / DC
- Current rating: 3A AC / DC
- Withstanding voltage: 1000V AC/minute
- Temperature range: -25° ~+85°
- Insulation resistance: ≥1000MΩ
- Contact resistance: ≤10mΩ
- After environmental testing: ≤20mΩ
- Material(Pin): Brass
- Mates With GYA Housing : 2011H-XXA

2011 WRS - 02 A1 - 9T SW XX
 ① ② ③ ④ ⑤ ⑥ ⑦ ⑧ ⑨



- ① Series No.
- ② Category: W-WAFER
- ③ Connector Type: R-90°
- ④ Mouting Type: S-SMT
- ⑤ Row No.-Pin No Per Row: 02P-Single Row
- ⑥ Plug the Pin & Special No.: A1-All Bags With Buckle
- ⑦ Plastic material: 9T -PA9T 94V-0
- ⑧ Plating Code: SW-Matte Tin Plating
- ⑨ Color : Blank-Natural Color

					GENERAL TOLERANCE .X ±0.35 .XX ±0.25 .XXX ±0.15 X.° ±2°				GYA 东莞市国亚电子有限公司 Connectors Dong Guan Guo Ya Connectors co., Ltd.				PART NO. 2011WRS-02A1-9TSWXX			
					PROJECT Yangzhengguo Yangzhengyi Lviansheng				APPROVAL CHECK DRAWN DATE Yangzhengguo Yangzhengyi Lviansheng 2016/08/26				TITLE 2.00mm Crimp Style Connectors			
DATE	REV	ECN NO.	DESCRIPTION	MODIFY	APPROVAL	UNIT	SCALE	SHEET	REV	NUMBER						
1	2					mm	1:1	1/1	A0	A-010						