

RoHS

■ Specifications :

- Voltage rating: 250V AC / DC
- Current rating: 3A AC / DC
- Withstanding voltage: 800V AC/minute
- Temperature range: -25° ~+85°
- Insulation resistance: ≥1000MΩ
- Contact resistance: ≤10mΩ
- After environmental testing: ≤20mΩ
- Mates With GYA Terminal:2006T
- Mates With GYA Wafer:2006W

2006 H X-2*XX X-N0 HF XX

① ② ③ ④ ⑤ ⑥ ⑦ ⑧

- ① Series No.
- ② Category: H-HSG
- ③ Appearance type: Blank-Ordinary
- ④ Row No.-Pin No.: 2*XX-2*04P~2*20P
- ⑤ Special No.: Blank-Ordinary
- ⑥ Material : N0-PA66 UL94V-0
- ⑦ HF-Halogen Free
- ⑧ Color:Blank-Nature

Poles	Dimensions (mm)				Poles	Dimensions (mm)			
	A	B	C	D		A	B	C	D
2*04	6.00	10.00	8.65	7.55	2*13	24.00	28.00	26.65	25.55
2*05	8.00	12.00	10.65	9.55	2*14	26.00	30.00	28.65	27.55
2*06	10.00	14.00	12.65	11.55	2*15	28.00	32.00	30.65	29.55
2*07	12.00	16.00	14.65	13.55	2*16	30.00	34.00	32.65	31.55
2*08	14.00	18.00	16.65	15.55	2*17	32.00	36.00	34.65	33.55
2*09	16.00	20.00	18.65	17.55	2*18	34.00	38.00	36.65	35.55
2*10	18.00	22.00	20.65	19.55	2*19	36.00	40.00	38.65	37.55
2*11	20.00	24.00	22.65	21.55	2*20	38.00	42.00	40.65	39.55
2*12	22.00	26.00	24.65	23.55					

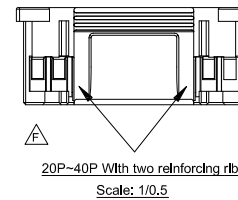
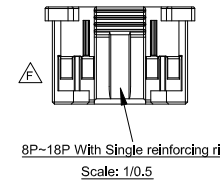
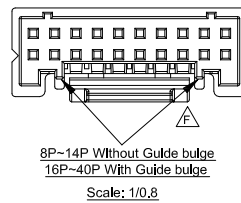
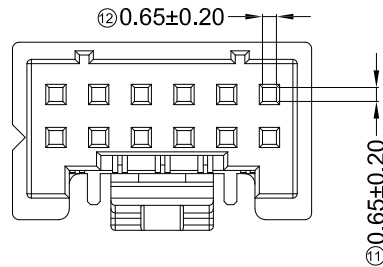
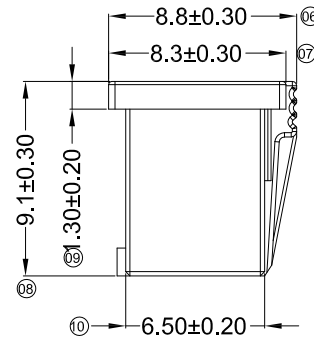
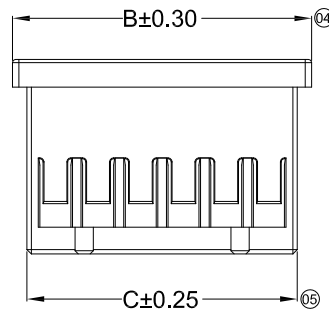
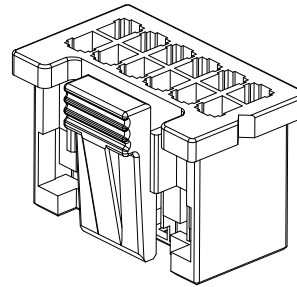
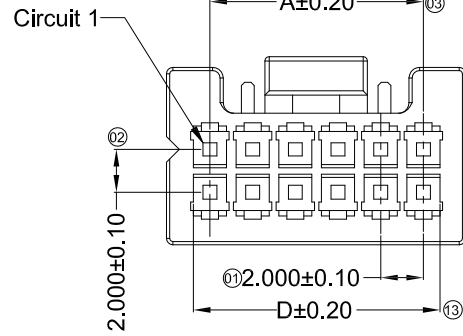

GENERAL TOLERANCE

.X ±0.35

.XX ±0.25

.XXX ±0.15

X.° ±2°

PROJECT

⊕ ⊖



东莞市国亚电子有限公司
Dong Guan Guo Ya Connectors co., Ltd.

APPROVAL

CHECK

DRAWN

DATE

Yangzhengguo

Yangzhengyi

Lvliansheng

2016/08/26

PART NO. 2006H-2*XX-N0HF

TITLE
2.00mm Crimp Style Connector

UNIT	SCALE	SHEET	REV	NUMBER
mm	1:1	1/2	A0	A-000

DATE	REV	ECN NO	DESCRIPTION	MODIFY	APPROVAL
1					

RoHS

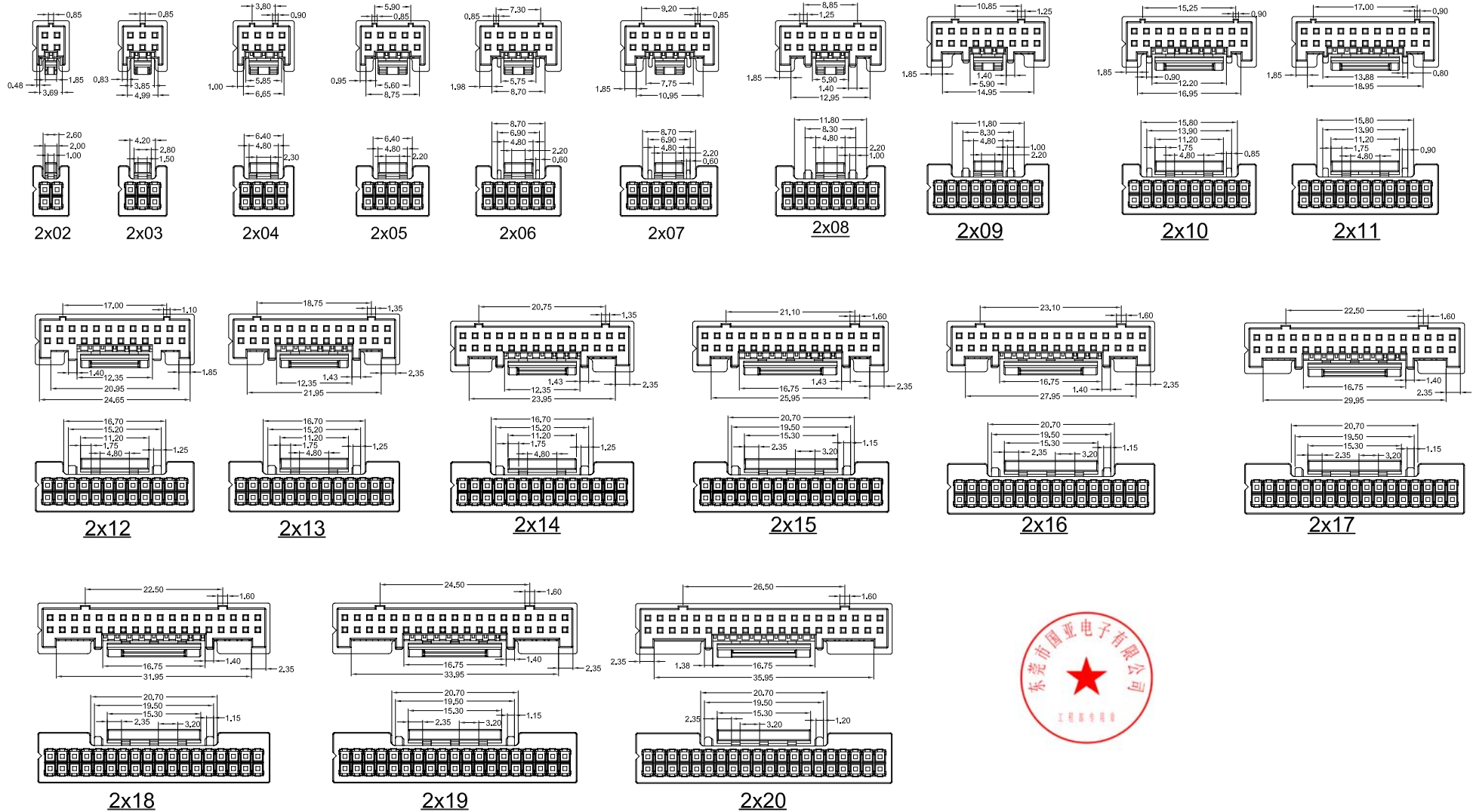

DATE	REV	ECN NO	DESCRIPTION	MODIFY	APPROVAL
1					
2					
3					
4					

GENERAL TOLERANCE
.X ±0.35
.XX ±0.25
.XXX ±0.15
X.° ±2°
PROJECT



东莞市国亚电子有限公司
Dong Guan Guo Ya Connectors co., Ltd.

APPROVAL	CHECK	DRAWN	DATE
Yangzhengguo	Yangzhengyi	Lviliansheng	2016/08/26

PART NO. 2006H-2*XX-N0HF				
TITLE 2.00mm Crimp Style Connector				
UNIT	SCALE	SHEET	REV	NUMBER
mm	1:1	2/2	A0	A-000

RoHS

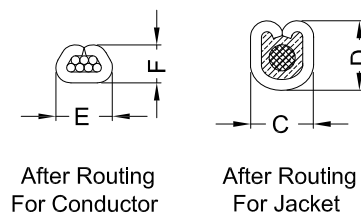
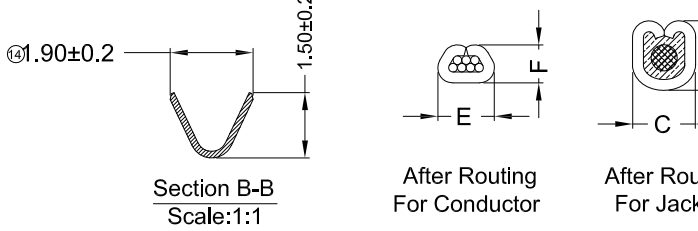
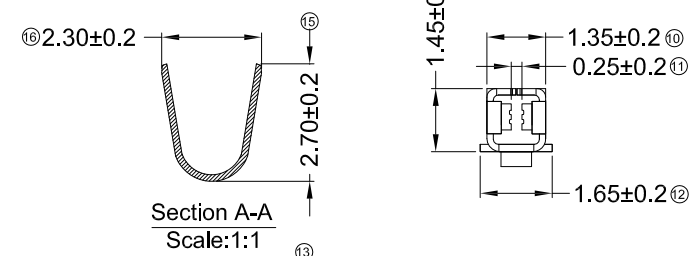
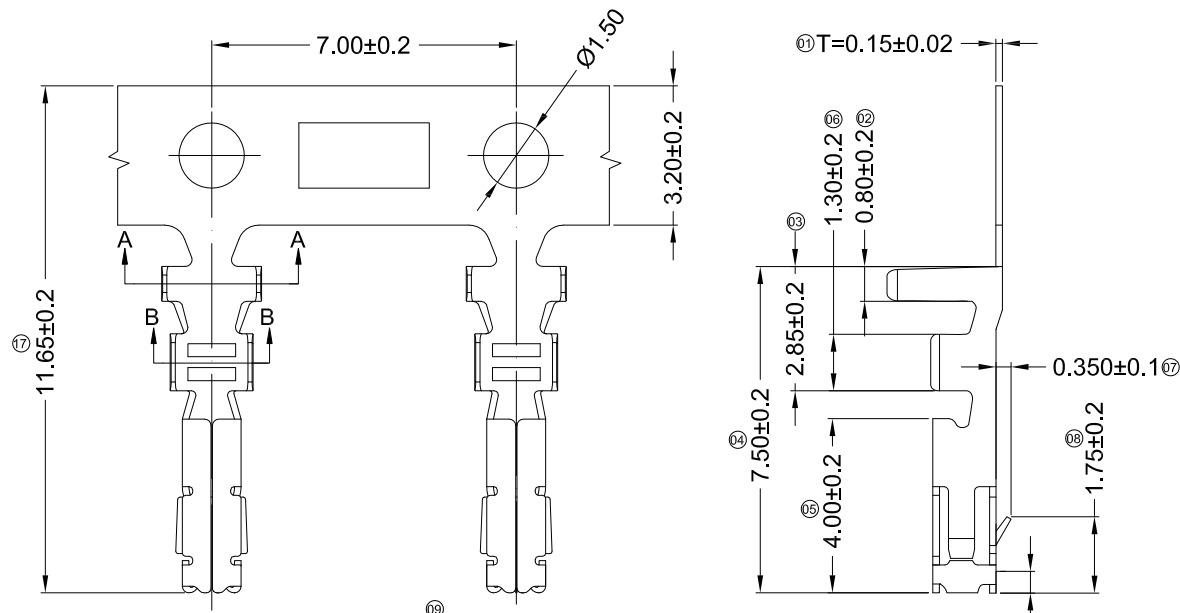

RECOMMENDED CABLE CRIMPING DIMENSION				
AWG#	C	D	E	F
AWG#28	1.40 MAX	1.10~1.20	1.10~1.20	0.65~0.70
AWG#26	1.40 MAX	1.20~1.30	1.10~1.20	0.70~0.75
AWG#24	1.40 MAX	1.30~1.40	1.10~1.20	0.75~0.80
AWG#22	1.40 MAX	1.40~1.50	1.10~1.20	0.80~0.85
WIRE RANGE	C	D	E	F
DIM. (mm)				

Specifications :

- Voltage rating: 250V AC / DC
- Current rating: 3A AC / DC
- Withstanding voltage: 800V AC/minute
- Temperature range: -25° ~+85°
- Insulation resistance: ≥1000MΩ
- Contact resistance: ≤10mΩ
- After environmental testing: ≤20mΩ
- Wire Range: AWG#22~AWG#28
- Insulation O.D: 1.50mm(Max)
- Mates With GYA Housing : 2006H

2006 T X-P XX X - X
① ② ③ ④ ⑤ ⑥ ⑦



- ① Series Number
- ② Category: T-Terminal
- ③ Shape: Blank-ordinary
- ④ Material: P-Phosphor bronze
- ⑤ Plating style:
SN-Bright Tin 100u" Min. Ni 30u" Min. under
V01-All Area G/F Ni 30u" Min. under
V15- Plated Test Point Au15u" Min. other Area G/F
Ni 30u" Min. under
- ⑥ Plating method:
Blank-Stamping before plating
B-Plating before stamping
- ⑦ Mold No./Mark/Special No.

					GENERAL TOLERANCE				PART NO. 2006T-PXXX-X				
					.X ±0.35				TITLE				
					.XX ±0.25				2.00mm Crimp Style Connectors				
					.XXX ±0.15				UNIT SCALE SHEET REV NUMBER				
					X.° ±2°				mm 1:1 1/1 A0 A-000				
DATE	REV	ECN NO	DESCRIPTION	MODIFY	APPROVAL	PROJECT	APPROVAL	CHECK	DRAWN	DATE			
1	2					Yangzhengguo	Yangzhengyi	Lviansheng	2016/08/26				

GYA 东莞市国亚电子有限公司
Connectors Dong Guan Guo Ya Connectors co., Ltd.

RoHS

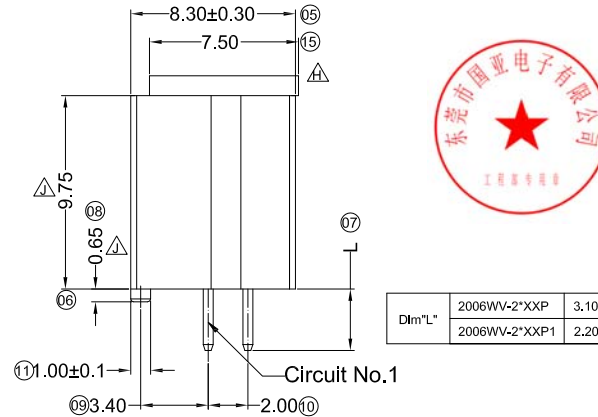
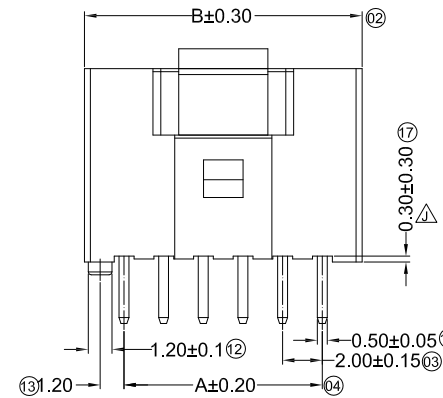
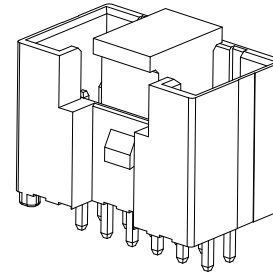
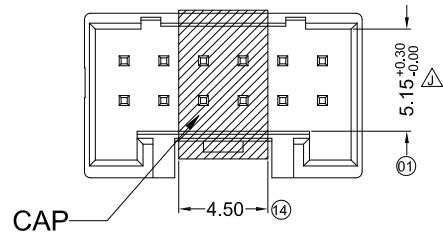

■ Specifications :

- Voltage rating: 250V AC / DC
- Current rating: 3A AC / DC
- Withstanding voltage: 800V AC/minute
- Temperature range: -25° ~+85°
- Insulation resistance: ≥1000MΩ
- Contact resistance: ≤10mΩ
- After environmental testing: ≤20mΩ
- Material(Pin): Brass
- Mates With GYA Housing 2006H

2006 W V X - 2*XX XX - 4T XX X - X - XX
 ① ② ③ ④ ⑤ ⑥ ⑦ ⑧ ⑨ ⑩ ⑪

- ① Series No.
- ② Category: W-WAFER
- ③ Connector Type: V-180°
- ④ Mounting Type: Blank-DIP
- ⑤ Row No.-Pin No.: 2*XX-2*02P~2*20P
- ⑥ Special No.:
 P-With Post ; DIP=3.10mm
 P1-With Post , DIP=2.20mm
- ⑦ Material: 4T-PA4T 94V-0
- ⑧ Plating Category:
 SW-Matte Tin 100u" Min. ; Ni 50u" Min.
 SN-Bright Tin 100u" Min. ; Ni 50u" Min.
- ⑨ Color :N-Natural Color
- ⑩ Packing: G-Tube/ Without CAP Blank-Reel / With CAP
- ⑪ Blank-No Date Code DC-With Date Code

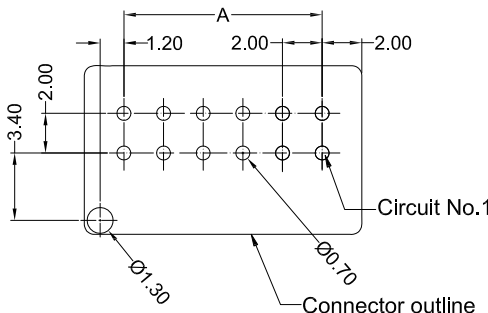

Recommended P.C.B Layout
 General Tolerance±0.05

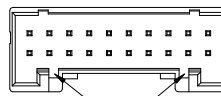
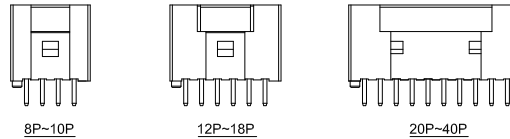

8P~14P Without Guideway
 16P~40P With Guideway
 Scale: 1/0.5

Poles	Dimensions (mm)		Poles	Dimensions (mm)	
	A	B		A	B
2*02	2.00	6.00	2*12	22.00	26.00
2*03	4.00	8.00	2*13	24.00	28.00
2*04	6.00	10.00	2*14	26.00	30.00
2*05	8.00	12.00	2*15	28.00	32.00
2*06	10.00	14.00	2*16	30.00	34.00
2*07	12.00	16.00	2*17	32.00	36.00
2*08	14.00	18.00	2*18	34.00	38.00
2*09	16.00	20.00	2*19	36.00	40.00
2*10	18.00	22.00	2*20	38.00	42.00
2*11	20.00	24.00			

DATE	REV	ECN NO.	DESCRIPTION	MODIFY	APPROVAL
1		2		4	

GENERAL TOLERANCE	
.X	±0.30
.XX	±0.20
.XXX	±0.10
X.°	±2°
PROJECT	
⊕	□



东莞市国亚电子有限公司
 Dong Guan Guo Ya Connectors co., Ltd.

APPROVAL	CHECK	DRAWN	DATE
Yangzhengguo	Yangzhengyi	Lvliansheng	2016/08/26

PART NO.				
2006WV-2*XX XX-4T XXX-X-XX				
TITLE 2.00mm Crimp Style Connector				
UNIT	SCALE	SHEET	REV	NUMBER
mm	1:1	1/1	A0	A-000

RoHS

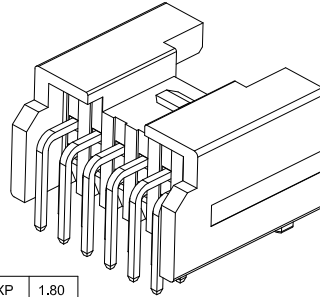
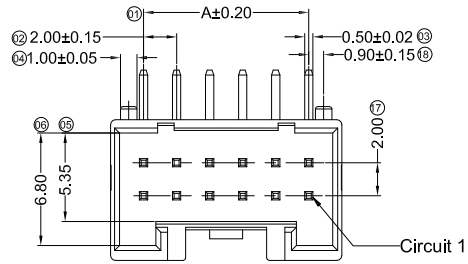

Dim"L"	2006WR-2*XXP	1.80
	2006WR-2*XXP1	3.00
	2006WR-2*XXP2	3.50

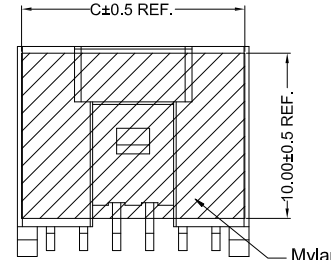
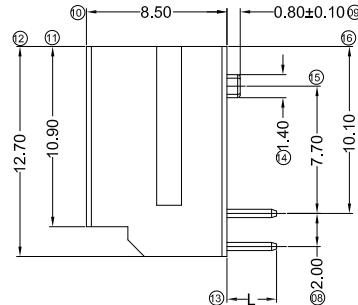
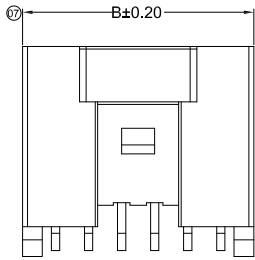

■ Specifications :

- Voltage rating: 250V AC / DC
- Current rating: 3A AC / DC
- Withstanding voltage: 800V AC/minute
- Temperature range: -25° ~+85°
- Insulation resistance: ≥1000MΩ
- Contact resistance: ≤10mΩ
- After environmental testing: ≤20mΩ
- Material(Pin): Brass
- Mates With GYA Housing 2006H

2006 W R X -2*XX XX -4T XX NX- X -XX
 ① ② ③ ④ ⑤ ⑥ ⑦ ⑧ ⑨ ⑩ ⑪ ⑫

- ① Series No.
- ② Category: W-WAFER
- ③ Connector Type: R- 90°
- ④ Mouting Type: Blank-DIP
- ⑤ Row No.-Pin No.: 2*XX-2*02~2*20P
- ⑥ Special No.:
 P-With Post ; DIP=1.80mm
 P1-With Post ; DIP=3.00mm
 P2-With Post ; DIP=3.50mm
- ⑦ Material: 4T-PA4T 94V-0
- ⑧ Plating Category:
 SW-Matte Tin 100u" Min. Ni 50u" Min.
 SN-Bright Tin 100u" Min. Ni 50u" Min.
 V15-Contact Area Au15u"Min. Solder Area G/F Ni 50u" Min.
- ⑨ Color:NW-Natural Color/ With Mylar N-Natural Color/ Without Mylar
- ⑩ Packing:G-Tube/ Without Mylar Blank-Reel/ With Mylar
- ⑪ DC-With Date Code Blank-No Date Code

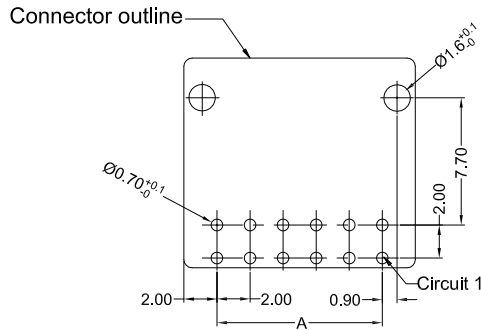

Recommended P.C.B Layout
 General Tolerance±0.05

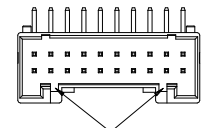
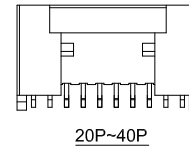
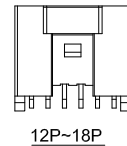
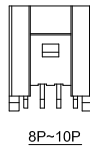
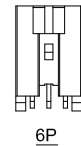

6P~14P Without Guideway
 16P~40P With Guideway
 Scale: 1/0.5



Poles	Dimensions (mm)			Poles	Dimensions (mm)		
	A	B	C		A	B	C
2*02	2.00	6.00	5.50	2*12	22.00	26.00	
2*03	4.00	8.00	7.50	2*13	24.00	28.00	
2*04	6.00	10.00	9.50	2*14	26.00	30.00	
2*05	8.00	12.00	11.50	2*15	28.00	32.00	
2*06	10.00	14.00	13.50	2*16	30.00	34.00	
2*07	12.00	16.00	13.50	2*17	32.00	36.00	
2*08	14.00	18.00	13.50	2*18	34.00	38.00	
2*09	16.00	20.00	13.50	2*19	36.00	40.00	
2*10	18.00	22.00		2*20	38.00	42.00	
2*11	20.00	24.00					

DATE	REV	ECN NO	DESCRIPTION	MODIFY	APPROVAL
1					
2					
3					
4					

GENERAL TOLERANCE	
.X	±0.30
.XX	±0.20
.XXX	±0.10
X.°	±2°
PROJECT	



东莞市国亚电子有限公司
 Dong Guan Guo Ya Connectors co., Ltd.

APPROVAL	CHECK	DRAWN	DATE
Yangzhengguo	Yangzhengyi	Lvliansheng	2016/08/26

PART NO. 2006WR-2*XXXX-4TXXNX-X-XX				
TITLE 2.00mm Crimp Style Connector				
UNIT	SCALE	SHEET	REV	NUMBER
mm	1:1	1/2	A0	A-000

RoHS

2.20

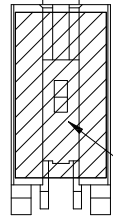

2x02

3.80

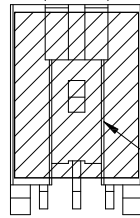

2x03

4.90

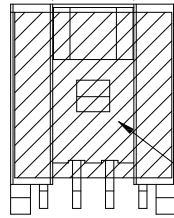

2x04

4.90

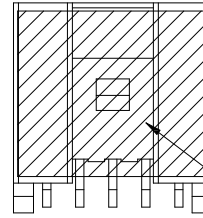

2x05

7.10
4.90

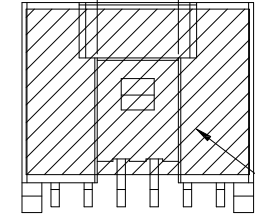

2X06~2X09

14.10

11.35

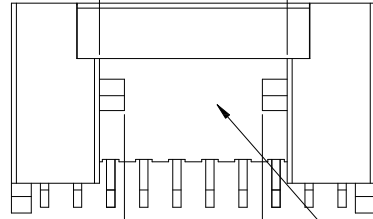

2X10~2X11

15.30

11.30

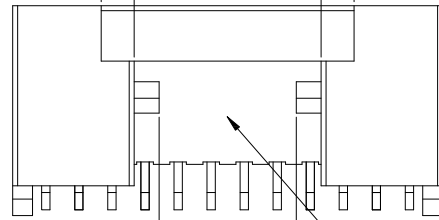

2X12~2X14

19.70

15.40

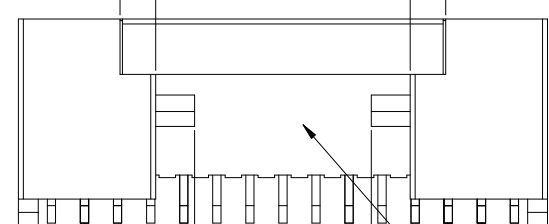

2X15~2X20

吸附Area Without Mylar

吸附Area Without Mylar

吸附Area Without Mylar



GENERAL TOLERANCE

.X ±0.35

.XX ±0.25

.XXX ±0.15

X.° ±2°

PROJECT

PROJECT SYMBOL



东莞市国亚电子有限公司
Dong Guan Guo Ya Connectors co., Ltd.

APPROVAL

CHECK

DRAWN

DATE

Yangzhengguo

Yangzhengyi

Lvtiansheng

2016/08/26

PART NO.

2006WR-2*XXXX-4TXXNX-X-XX

TITLE 2.00mm Crimp Style Connector

UNIT

SCALE

SHEET

REV

NUMBER

mm

1:1

2/2

A0

A-000

DATE

1

REV

2

ECN NO

DESCRIPTION

MODIFY

4

APPROVAL

5

APPROVAL

CHECK

DRAWN

DATE

Yangzhengguo

Yangzhengyi

Lvtiansheng

2016/08/26

UNIT

SCALE

SHEET

REV

NUMBER

mm

1:1

2/2

A0

A-000

1

2

3

4

5

6

7

8