

RoHS

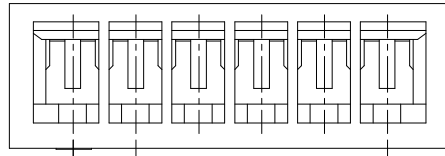

1.00 ①
② A±0.20

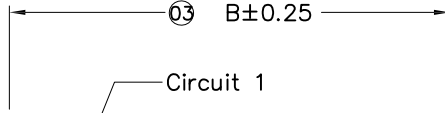

③ B±0.25

Circuit 1

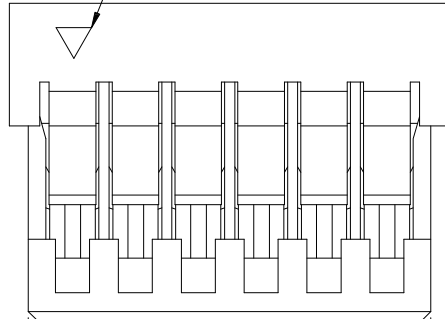

④ C±0.10

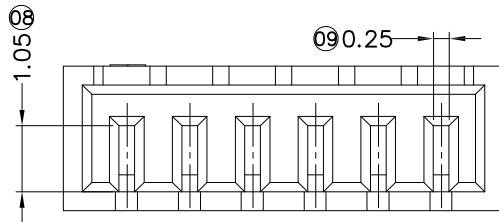

⑨ 1.05

⑩ 0.25

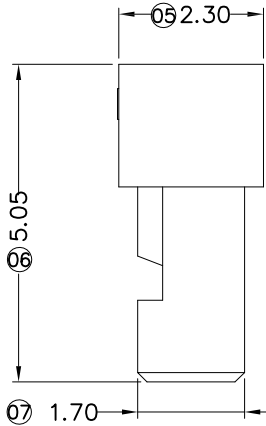
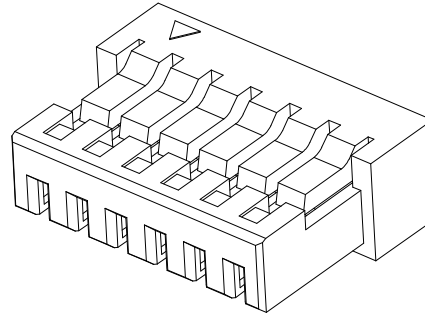

⑥ 2.30

⑦ 1.70

Specifications :

- Voltage rating: 125V AC / DC
- Current rating: 1A AC / DC
- Withstanding voltage: 500V AC/minute
- Temperature range: -25° ~+85°
- Insulation resistance: ≥100MΩ
- Contact resistance: ≤20mΩ
- After environmental testing: ≤40mΩ
- Suitable GYA Terminal: 1002T-A

1002 H -XX A-NO HF XX

① ② ③ ④ ⑤ ⑥ ⑦

- ① Series No.
- ② Category : H-HSG
- ③ Pin No.: XX-02P~16P
- ④ Special No. A-Ultra-thin
- ⑤ Material : NO-PA66 94V-0
- ⑥ HF-Halogen Free
- ⑦ Color:Blank-Natural Color BK-Black



Poles	Dimensions (mm)			Poles	Dimensions (mm)		
	A	B	C		A	B	C
02	1.00	3.00	2.40	10	9.00	11.00	10.40
03	2.00	4.00	3.40	11	10.00	12.00	11.40
04	3.00	5.00	4.40	12	11.00	13.00	12.40
05	4.00	6.00	5.40	13	12.00	14.00	13.40
06	5.00	7.00	6.40	14	13.00	15.00	14.40
07	6.00	8.00	7.40	15	14.00	16.00	15.40
08	7.00	9.00	8.40	16	15.00	17.00	16.40
09	8.00	10.00	9.40				

DATE	REV	ECN NO	DESCRIPTION	MODIFY	APPROVAL
1					
2					
3					
4					
5					

GENERAL TOLERANCE	
.X	±0.30
.XX	±0.20
.XXX	±0.10
X.*	±2°
PROJECT	
①	②



东莞市国亚电子有限公司
Dong Guan Guo Ya Connectors co., Ltd.

APPROVAL	CHECK	DRAWN	DATE
Yangzhengguo	Yangzhengyi	Lvtiansheng	2016/08/26

PARTNO.				
1002H-XXA-NOHFXX				
TITLE				
1.00 mm Crimp Style Connectors				
UNIT	SCALE	SHEET	REV	NUMBER
mm	1:1	1/1	A0	A-241

RoHS

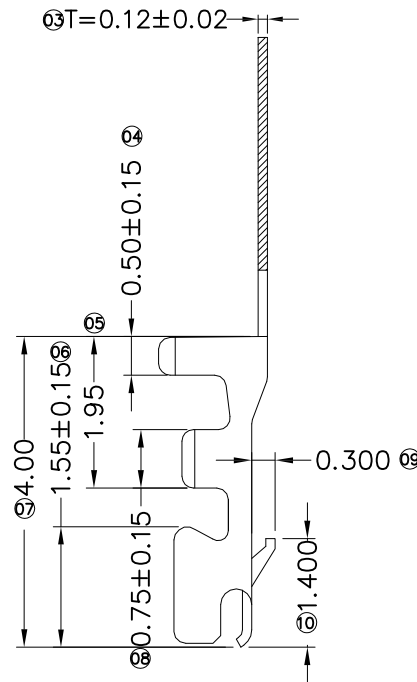
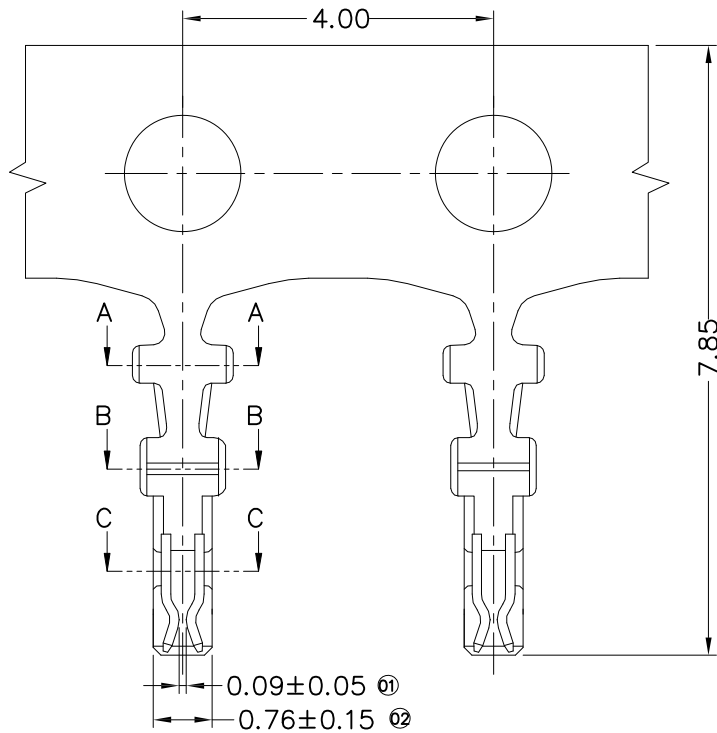

- Specifications :
- Voltage rating: 125V AC / DC
 - Current rating: 1A AC / DC
 - Withstanding voltage: 500V AC/minute
 - Temperature range: -25° ~ +85°
 - Insulation resistance: ≥100MΩ
 - Contact resistance: ≤20mΩ
 - After environmental testing: ≤40mΩ
 - Wire Range : AWG#28-32
 - Insulation O.D. : 0.92mm
 - Used In GYA Housing : 1002H-A ,1002H-B

1002 T X-P XX X-A
 ① ② ③ ④ ⑤ ⑥ ⑦

- ① Series Number
- ② Category: T-terminal
- ③ Shape: Blank-ordinary
- ④ Material: P-Phosphor bronze
- ⑤ Plating code:
 V01-All Gold Flash
 SN-Bright tin plating 70u" ; 30u" Ni
 SN2-50u" Ni Min,120u" Tin Min
- ⑥ Plating method: Blank-Stamping before plating
- ⑦ Mold No./Mark/Special No. A-Ultra-thin

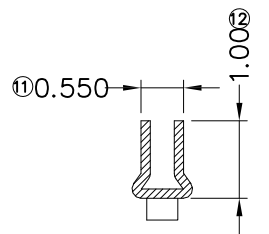

SECTION C-C
SCALE 1:1

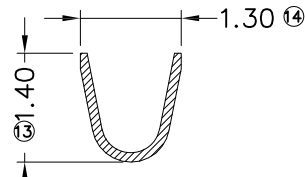

SECTION A-A
SCALE 1:1

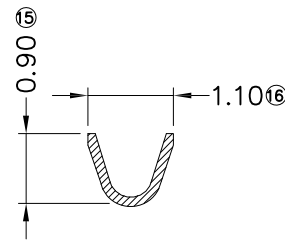

SECTION B-B
SCALE 1:1



					GENERAL TOLERANCE .X ±0.30 .XX ±0.20 .XXX ±0.10 X.' ±2° PROJECT 				GYA 东莞市国亚电子有限公司 Connectors Dong Guan Guo Ya Connectors co.,ltd.				PARTNO. 1002T-PXX-A TITLE 1.00 mm Crimp Style Connectors				
					APPROVAL Yangzhengguo		CHECK Yangzhengyi		DRAWN Lvtiansheng		DATE 2016/08/26						
DATE	REV	ECN NO	DESCRIPTION	MODIFY	APPROVAL	UNIT	SCALE	SHEET	REV	NUMBER							
						mm	1:1	1/1	A0	A-014							

RoHS

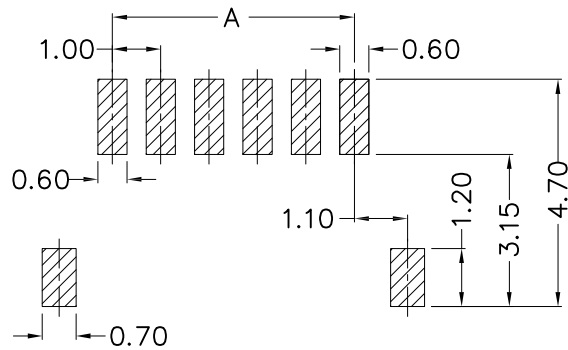
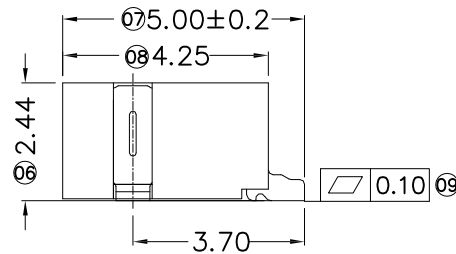
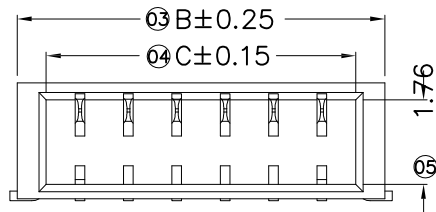
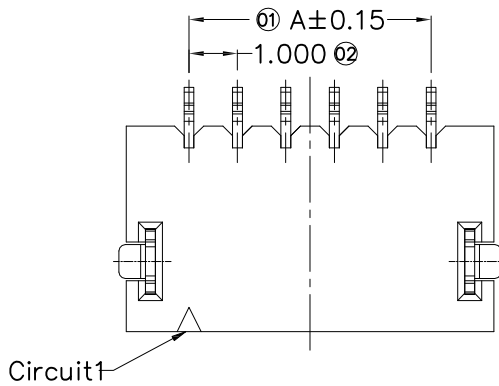

Recommended P.C.B Layout
General Tolerance±0.05

■ Specifications :

- Voltage rating: 125V AC / DC
- Current rating: 1A AC / DC
- Withstanding voltage: 500V AC/minute
- Temperature range: -25° ~+85°
- Insulation resistance: ≥100MΩ
- Contact resistance: ≤20mΩ
- After environmental testing: ≤40mΩ
- Mates With GYA Housing : 1002H-XXA

1002 W R S-XX A-9T SN XX

① ② ③ ④ ⑤ ⑥ ⑦ ⑧ ⑨

- ① Series No.
- ② Category : W-wafer
- ③ Connector type: R-Right Angle 90°
- ④ Mounting type: S-SMT
- ⑤ Row No.-Pin No per row: XX-Single Row
- ⑥ Special No.: A-On both sides of the inserted into the positioning piece in the middle
- ⑦ Material : 9T-PA9T 94V-0
- ⑧ Plating code: SN-Bright tin plating
- ⑨ Color: Blank-natural color



Poles	Dimensions(mm)			Poles	Dimensions(mm)		
	A	B	C		A	B	C
02	1.00	3.50	2.50	10	9.00	11.50	10.50
03	2.00	4.50	3.50	11	10.00	12.50	11.50
04	3.00	5.50	4.50	12	11.00	13.50	12.50
05	4.00	6.50	5.50	13	12.00	14.50	13.50
06	5.00	7.50	6.50	14	13.00	15.50	14.50
07	6.00	8.50	7.50	15	14.00	16.50	15.50
08	7.00	9.50	8.50	16	15.00	17.50	16.50
09	8.00	10.50	9.50				

GENERAL TOLERANCE					PROJECT	APPROVAL	CHECK	DRAWN	DATE	PARTNO. 1002WRS-XXA-9TSN	TITLE 1.00 mm Crimp Style Connectors										
.X	±0.30	.XX	±0.20	.XXX								±0.10	X.*	±2°	UNIT	SCALE	SHEET	REV	NUMBER		
DATE	REV	ECN NO	DESCRIPTION	MODIFY								APPROVAL	Yangzhengguo	Yangzhengyi	Lvtiansheng	2016/08/26	mm	1:1	1/1	A0	A-229



东莞市国亚电子有限公司
Dong Guan Guo Ya Connectors co., Ltd.

UNIT	SCALE	SHEET	REV	NUMBER
mm	1:1	1/1	A0	A-229