

RoHS

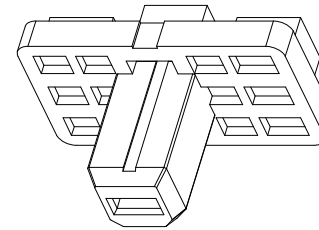
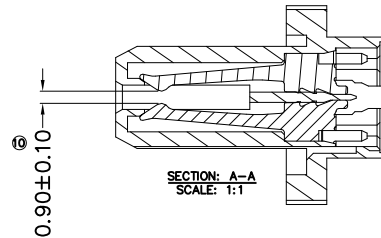
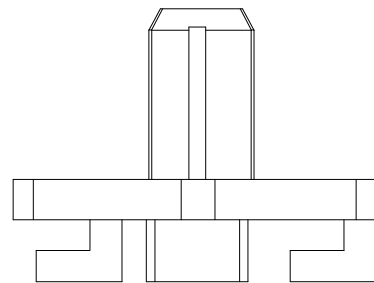
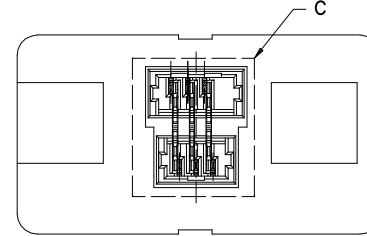
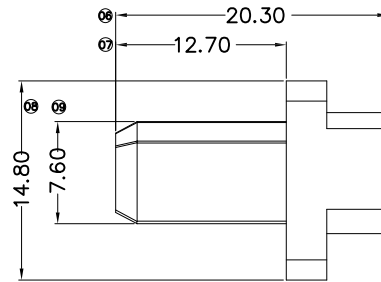
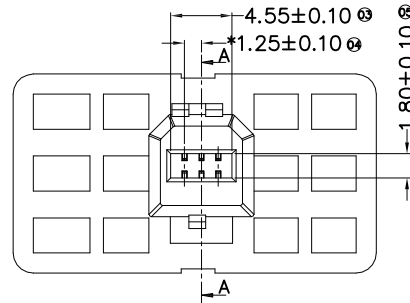
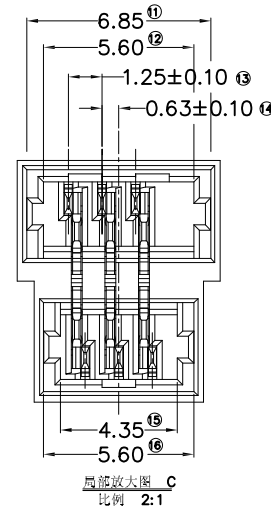
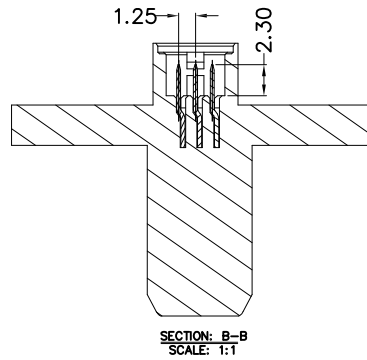
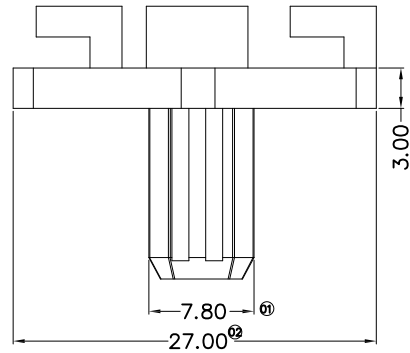

■ Specifications :

- Voltage rating: 125V AC / DC
- Current rating: 1.0A AC / DC
- Withstanding voltage: 500V AC/minute
- Temperature range: -25° ~ +85°
- Insulation resistance: ≥100MΩ
- Contact resistance: ≤20mΩ
- After environmental testing: ≤40mΩ
- Material(Pin): Phosphor bronze
- Mates With GYA Wafer : B0125V

0125 W V A - 2 x 03 - N0 B P 37 B R 001 F  
 ① ② ③ ④ ⑤ ⑥ ⑦ ⑧ ⑨ ⑩ ⑪ ⑫ ⑬

- ① Series No.
- ② Category: W-wafer
- ③ Connector type: V-Straight 180°
- ④ Mating type: A-Male Housing
- ⑤ Row No.-Pin No per row: 2x03-Single Row 2x03Pin
- ⑥ Plastic material: N0- PA66 94V-0;
- ⑦ Color: B-Black;
- ⑧ Metal material: P-Phosphor bronze
- ⑨ Plating Code: 37- nickel base at all area Min 50 u", bright tin Min 100 u", gold-plated at contact region Min 3 u".
- ⑩ Packag: B-bags
- ⑪ Green code: R-RoHS
- ⑫ Water code: 001
- ⑬ Special code:  
F-----Other Connectors

						<b>GENERAL TOLERANCE</b> .X ±0.30 .XX ±0.20 .XXX ±0.10				<b>GYA</b> 东莞市国亚电子有限公司 Connectors Dong Guan Guo Ya Connectors co., ltd.				<b>PARTNO.</b> 0125MVA-2x03-N0BP37BR001F							
						<b>APPROVAL</b> Yangzhengguo				<b>CHECK</b> Yangzhengyi				<b>DRAWN</b> Lvtiansheng				<b>DATE</b> 2016/08/26			
						<b>PROJECT</b> 				<b>TITLE</b> 1.25mm Crimp Style Connectors											
DATE	REV	ECN NO.	DESCRIPTION	CHECK	APPROVAL	UNIT	SCALE	SHEET	REV	NUMBER	mm	1:1	1/1	A0	A-014						